

S8

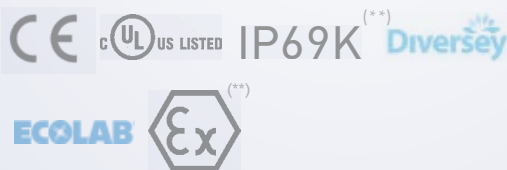

IO-Link^(*)
New ASIC



COMPACT SIZE AND HIGH PERFORMANCE FOR THE MOST CHALLENGING DETECTION APPLICATIONS LINKED TO YOUR INDUSTRY 4.0 APPLICATIONS

- Compact dimensions (14x42x25 mm)
- Background suppression for transparent and shiny objects
- Contrast sensors up to 25 kHz switching frequency
- Extremely focused spot, under 1 mm (LASER model)
- Very high resolution LASER models
- INOX AISI 316L model
- Extended IO-Link parametrization with counter
- All output fully PNP/NPN/PP IO-Link configurable
- IO-link COM2
- IO-Link dual channel with no jitter addition

APPLICATIONS

- Processing and Packaging machinery
- Beverage/Food/ Cosmetics/Pharmaceutical industries
- Electronics assembling

(**) Stainless steel models.
ATEXII 3DG

S8		
Through beam	0...25 m	
Polarized retroreflective	0,1...5 m	
Polarized retroreflective (coaxial)	0...10 m (class 1 LASER - B51,B53...OZ)	
Retroreflective for transparent (coaxial)	0...0,8 m (T51), 0...2 m (T53...OZ, T50)	
Diffuse proximity	0...500 mm	
Background suppression	50...300 mm	
Background suppression for clear detection	20...200 mm (class 1 LASER)	
	100...300 mm (LED)	
	50...150 mm (class 1 LASER)	
Contrast sensor	10 mm (Wxx, W03...OZ)	
Luminescence sensor	10...30 mm (U03, U03...OZ)	
Power supply	Vdc	12...30 V
	Vac	
	Vac/dc	
Output	PNP	•
	NPN	•
	NPN/PNP	IO-Link PNP/NPN/Push Pull (S8...B53/T53/W03/U03...OZ)
	relay	
	other	IO-Link dual channel COM2 2,3ms cycle time
Connection	cable	•
	connector	•
	pig-tail	•
Approximate dimensions (mm)	14x42x25	
Housing material	ABS, Stainless Steel AISI 316L	
Mechanical protection	IP69K (Stainless Steel AISI 316L vers.), IP67	

TECHNICAL DATA

Power supply	12 ... 30 Vdc (battery inversion protected)
Ripple	2 Vpp max.
Consumption (output current excluded)	30 mA; 35 mA (mod. S8...M01); 20 mA (mod. S8...F), 15 mA (mod. S8...G) max.; 40mA max. all IO-Link Models red LED 660 nm (mod. S8...B01/C/M/G/T)
Light emission	RGB LEDs: blue 465 nm, green 520 nm, red 630nm with automatic selection (mod. S8...W)
	UV LED 375 nm (mod. S8...U)
	red Laser 645..665 nm (mod. S8...B51/B53/M) Class 1
Sensitivity Setting	8-turn distance adjustment trimmer (mod. S8...M53/M)
	teach-in push button (mod. S8...B53/B53...OZ/M53/W03/W03...OZ/W13/T53/T53...OZ/U03/U03...OZ)
	remote input (mod. S8...M53)
	mono-turn trimmer (mod. S8...B01/C/F/M/T51)
Operating mode	automatic auto adjustment (mod. S8...W/T50)
	remote input (mod. S8...M53)
	LIGHT / DARK mono-turn trimmer (mod. S8...B/C/F/T51/T53/U)
Indicators	yellow OUTPUT LED (all models excl. mod. S8...G), OUTPUT/ALARM LED (mod. S8...M53/M/C) green POWER LED
Output	PNP or NPN N.O. ; PNP/NPN/Push Pull fully configurable outputs for all IO-Link models (S8...B53/T53/W03/U03...OZ)
Output current	100 mA (overload protection and short circuit)
Saturation voltage	2 V max.
Response time	1 ms (mod. S8...M53/M)
	500 µs (mod. S8...B/F/C)
	250 µs (mod. S8...T/T53...OZ IO-Link)
	100 µs (Laser vers. mod. S8...M)
	50 µs (mod. S8...W00/W03/W03...OZ IO-Link and Laser mod. S8...B51/B53...OZ IO-Link)
	20 µs (mod. S8...W13)
Switching frequency	250 µs... 1 ms (mod. S8...U) and U03...OZ IO-Link
	500 Hz (mod. S8...M53/M)
	1 kHz (mod. S8...B/F/C)
	2 kHz (mod. S8...T/T53...OZ IO-Link)
	5 kHz (Laser vers. mod. S8...M)
	10kHz (mod. S8...W00/W03/W03...OZ IO-Link and Laser mod. S8...B51/B53...OZ IO-Link)
	25 kHz (mod. S8...W13)
	500 Hz... 2 kHz (mod. S8...U) and U03...OZ IO-Link
Communication	IO-Link COM2 V1.1.2 2,3ms cycle time
Connection	M8 4-pole connector, 150 mm length Ø 4 mm cable with M12 4-pole connector (pig-tail vers.)
Dielectric strength	1500 VAC 1 min between electronic parts and housing
Insulating resistance	>20 MΩ 500 VDC between electronic parts and housing
Mechanical protection	IP67, IP69K (mod. S8-M)
Ambient light rejection	according to EN 60947-5-2
Vibrations	0.5 mm amplitude, 10 ... 55 Hz frequency, for every axis (EN60068-2-6)
Shock resistance	11 ms (30 G) 6 shocks per every axis (EN60068-2-27)
Housing material	ABS, Stainless Steel AISI 316L
Optical window material	window in PMMA; lens in PC
Operating temperature	-10 ... 55 °C
Storage temperature	-20 ... 70 °C
Weight	12 g max. conn. vers., 50 g pig-tail vers., 70 g max. (mod. S8-M)

CONNECTIONS

STANDARD MODELS

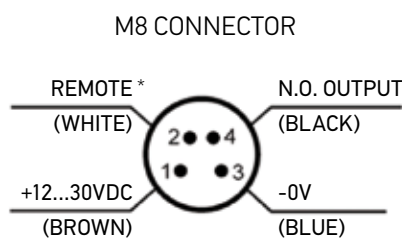
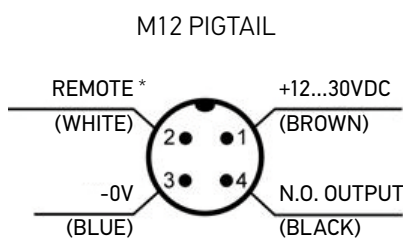

IO-LINK MODELS (M8 CONNECTOR ONLY)

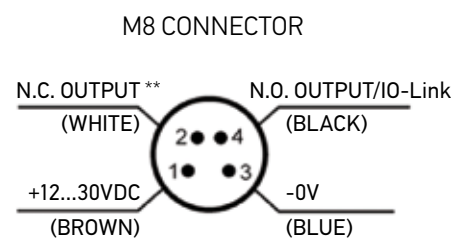

* REMOTE INPUT (mod. S8...W, U, T50, T53), LIGHT / DARK INPUT (mod. S8...M53), DELAY (mod. S8...M Laser), TEST INPUT (mod. S8...G), ALARM OUTPUT (mod. S8...B, T51), NOT USED (mod. S8...C, M, F)

** Fully configurable I/O Pin input or output by IO-Link setting

DIMENSIONS

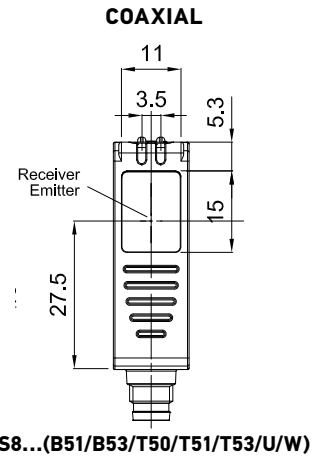
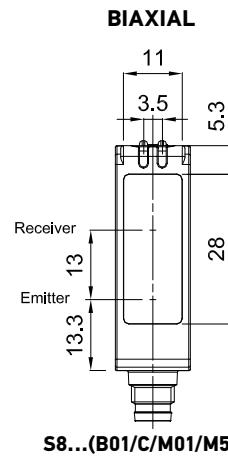
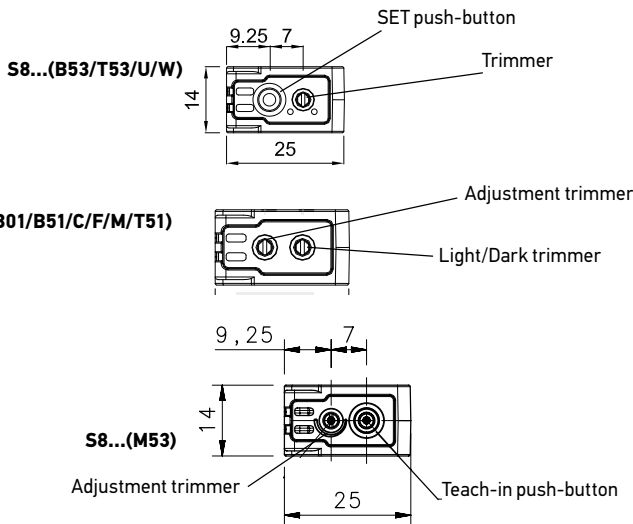
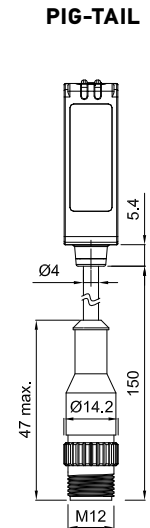
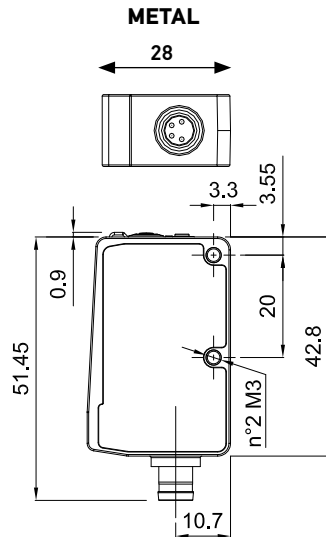
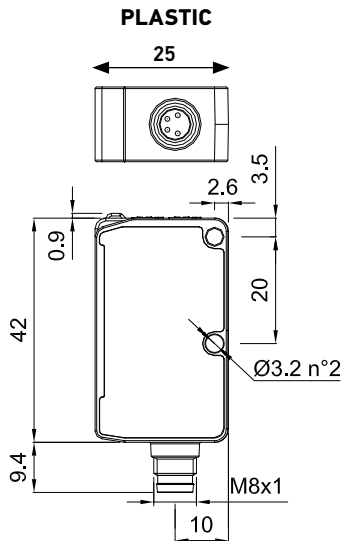

Note : T50 has no settings, only indicators

INDICATOR AND SETTING

S8...B01/B51//C/F/M/T51

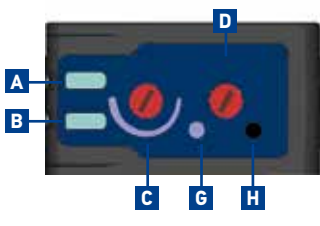

S8...B53/T53/U/W

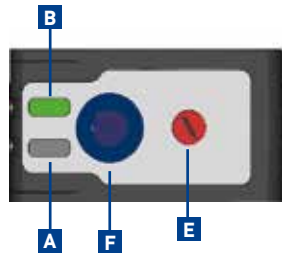

- A** Output status LED
- B** Ready LED or Power ON LED
- C** Sensitivity adjustment trimmer
- D** Dark/light trimmer

- E** Delay trimmer
- F** SET push-button
- G** Light
- H** Dark

Note : T50 has no settings, only indicators

READING DIAGRAMS

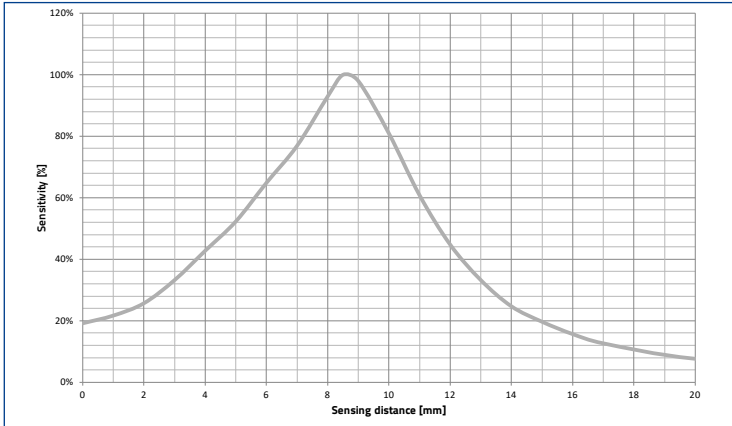

Contrast sensor (W00, W03...OZ, W13)

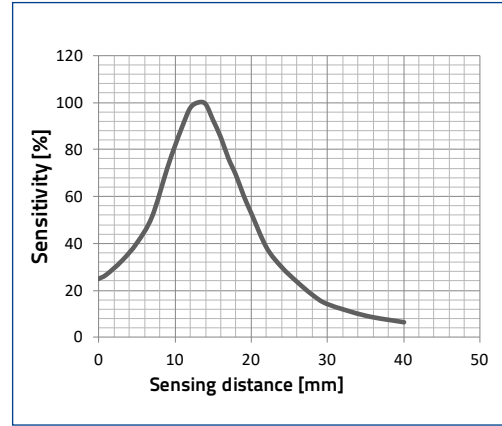

Luminescence sensor (U03...OZ)

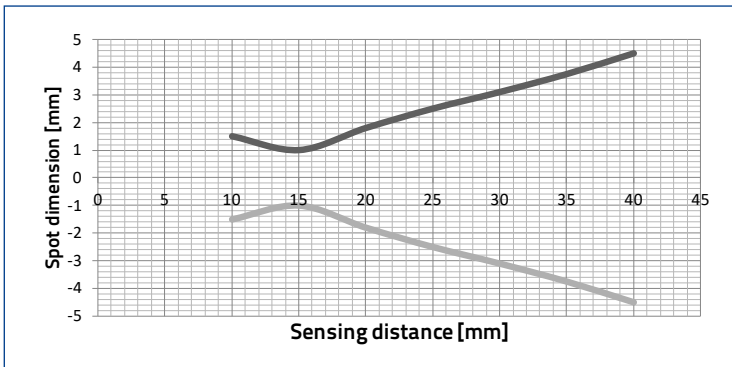

Luminescence sensor (U03/U03...OZ)

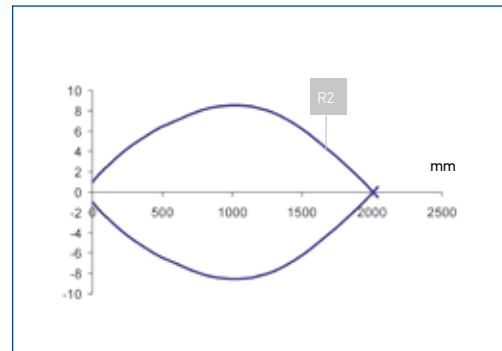

Coaxial Polarized Retroreflective for Transparents (T50/T53/T53...OZ)

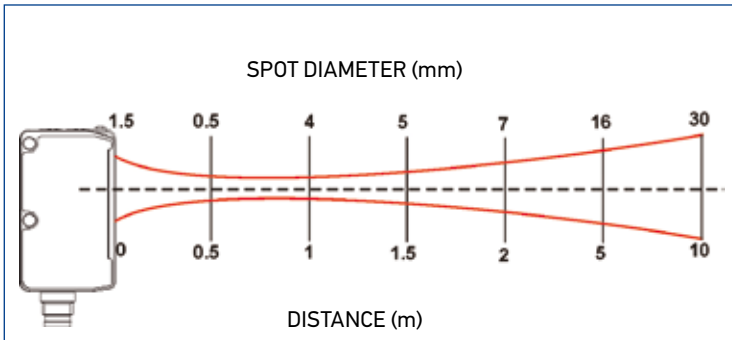

Spot Diameter Polarized Retroreflective Coaxial (LASER/B51/B53...OZ)

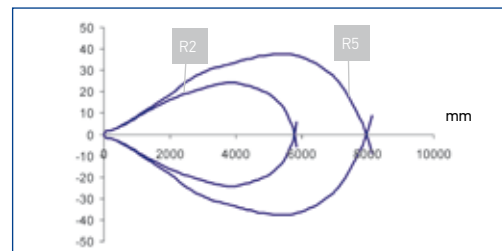

Polarized Retroreflective (LED/B01)

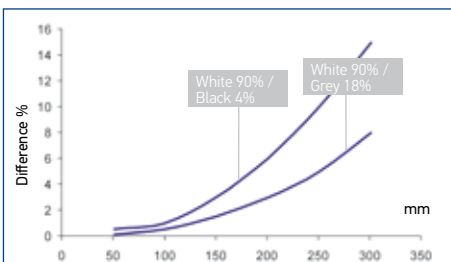

Background suppression (LED/M01)

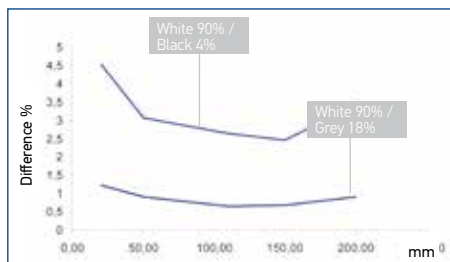

Background suppression (LASER/M01)

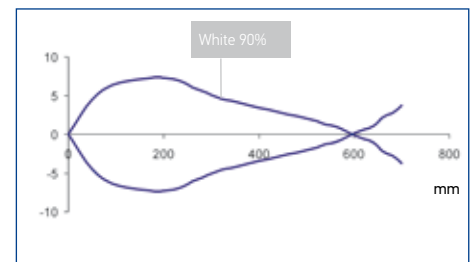

Diffuse Proximity (C01)

MODEL SELECTION AND ORDER INFORMATION

CLEAR DETECTION						
HOUSING	OPTIC TYPE	LIGHT EMISSION	CONNECTION	OUTPUT	MODEL	ORDER NO.
METAL Stainless Steel (INOX AISI 316L)	Axial	LASER	M8 connector	PNP	S8-MH-5-M53-PP	950801451
		LED			S8-MR-5-M53-PP	950801600
LASER		S8-PH-5-M53-PP			950801381	
LED		S8-PR-5-M53-PP			950801590	
PLASTIC ABS						

RETROREFLECTIVE FOR TRSPARENT						
HOUSING	OPTIC TYPE	LIGHT EMISSION	CONNECTION	OUTPUT	MODEL	ORDER NO.
METAL Stainless Steel (INOX AISI 316L)	Coaxial	LED	M8 connector	NPN	S8-MR-5-T50-NH	950801330
				PNP	S8-MR-5-T50-PH	950801320
			M8 connector	NPN	S8-MR-5-T53-NN	950801310
				PNP	S8-MR-5-T53-PP *	950801300
PLASTIC ABS			pig-tail	NPN	S8-PR-3-T51-NN	950801130
				PNP	S8-PR-3-T51-PP	950801120
			M8 connector	PNP/NPN/Push Pull	S8-PR-5-T53-OZ 	950800005
				NPN	S8-PR-5-T51-NN	950801050
	M8 connector	PNP	S8-PR-5-T51-PP	950801040		
	M8 connector	NPN	S8-PR-5-T53-NN	950801290		
		PNP	S8-PR-5-T53-PP *	950801280		

*Note: With Auto adaptive function

POLARIZED RETROREFLECTIVE						
HOUSING	OPTIC TYPE	LIGHT EMISSION	CONNECTION	OUTPUT	MODEL	ORDER NO.
METAL Stainless Steel (INOX AISI 316L)	Coaxial	LASER	M8 connector	NPN	S8-MH-5-B51-NN	950801490
				PNP	S8-MH-5-B51-PP	950801480
	Axial	LED		NPN	S8-MR-5-B01-NN	950801420
				PNP	S8-MR-5-B01-PP	950801410
PLASTIC ABS	Coaxial	LASER	pig-tail	NPN	S8-PH-3-B51-NN	950801090
				PNP	S8-PH-3-B51-PP	950801080
			M8 connector	NPN	S8-PH-5-B51-NN	950801010
				PNP	S8-PH-5-B51-PP	950801000
	Axial	LED	pig-tail	PNP/NPN/Push Pull	S8-PH-5-B53-OZ 	950800006
				NPN	S8-PR-3-B01-NN	950801190
			M8 connector	PNP	S8-PR-3-B01-PP	950801180
				NPN	S8-PR-5-B01-NN	950801170
		PNP	S8-PR-5-B01-PP	950801160		

BACKGROUND SUPPRESSION						
HOUSING	OPTIC TYPE	LIGHT EMISSION	CONNECTION	OUTPUT	MODEL	ORDER NO.
METAL Stainless Steel (INOX AISI 316L)	Axial	LASER	M8 connector	NPN	S8-MH-5-M01-NN	950801470
				PNP	S8-MH-5-M01-PP	950801460
		LED		NPN	S8-MR-5-M01-NN	950801400
				PNP	S8-MR-5-M01-PP	950801390
PLASTIC ABS		LASER	pig-tail	NPN	S8-PH-3-M01-NN	950801110
				PNP	S8-PH-3-M01-PP	950801100
			M8 connector	NPN	S8-PH-5-M01-NN	950801030
				PNP	S8-PH-5-M01-PP	950801020
	LED	pig-tail	NPN	S8-PR-3-M01-NN	950801230	
			PNP	S8-PR-3-M01-PP	950801220	
		M8 connector	NPN	S8-PR-5-M01-NN	950801210	
			PNP	S8-PR-5-M01-PP	950801200	

THROUGH BEAM						
HOUSING	OPTIC TYPE	LIGHT EMISSION	CONNECTION	OUTPUT	MODEL	ORDER NO.
METAL Stainless Steel (INOX AISI 316L)	Axial	LED	M8 connector	NPN	S8-MR-5-F01-NN	950801570
				PNP	S8-MR-5-F01-PP	950801560
emitter				S8-MR-5-G00-XG	950801580	
PLASTIC ABS			pig-tail	NPN	S8-PR-3-F01-NN	950801530
				PNP	S8-PR-3-F01-PP	950801520
				emitter	S8-PR-3-G00-XG	950801550
M8 connector			NPN	S8-PR-5-F01-NN	950801510	
			PNP	S8-PR-5-F01-PP	950801500	
			emitter	S8-PR-5-G00-XG	950801540	

DIFFUSE						
HOUSING	OPTIC TYPE	LIGHT EMISSION	CONNECTION	OUTPUT	MODEL	ORDER NO.
METAL Stainless Steel (INOX AISI 316L)	Axial	LED	M8 connector	NPN	S8-MR-5-C01-NN	950801440
				PNP	S8-MR-5-C01-PP	950801430
pig-tail			NPN	S8-PR-3-C01-NN	950801270	
			PNP	S8-PR-3-C01-PP	950801250	
M8 connector			NPN	S8-PR-5-C01-NN	950801260	
			PNP	S8-PR-5-C01-PP	950801240	

CONTRAST (RGB LED EMISSION LIGHT)							
HOUSING	OPTIC TYPE	SWITCHING FREQUENCY	CONNECTION	OUTPUT	MODEL	ORDER NO.	
METAL Stainless Steel (INOX AISI 316L)	Coaxial	10 kHz	M8 connector	PNP	S8-MR-5-W00-PH *	950801360	
				NPN	S8-MR-5-W00-NH *	950801370	
				PNP	S8-MR-5-W03-PP	950801340	
				NPN	S8-MR-5-W03-NN	950801350	
PLASTIC ABS			M12 pig-tail (150 mm)	PNP	S8-PR-3-W03-PP	950801140	
				NPN	S8-PR-3-W03-NN	950801150	
				PNP	S8-PR-5-W03-PP	950801060	
				NPN	S8-PR-5-W03-NN	950801070	
METAL Stainless Steel (INOX AISI 316L)		M8 connector	25 kHz	M8 connector	PNP/NPN/Push Pull 	S8-PR-5-W03-OZ	950800004
					PNP	S8-MR-5-W13-PP	950801670
					NPN	S8-MR-5-W13-NN	950801680
					PNP	S8-PR-5-W13-PP	950801650
PLASTIC ABS	M12 pig-tail (150 mm)	M12 pig-tail (150 mm)		M12 pig-tail (150 mm)	NPN	S8-PR-5-W13-NN	950801660
					PNP	S8-PR-3-W13-PP	950801690
					NPN	S8-PR-3-W13-NN	950801700

*Note: Without regulation

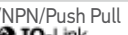
LUMINESCENCE (UV LED EMISSION LIGHT)								
HOUSING	OPTIC TYPE	SETTINGS	CONNECTION	OUTPUT	MODEL	ORDER NO.		
METAL Stainless Steel (INOX AISI 316L)	Coaxial	Teach-in push-button; L/D trimmer selector; Remote Input	M8 connector	PNP	S8-MR-5-U03-PP	950801630		
				NPN	S8-MR-5-U03-NN	950801640		
PNP				S8-PR-5-U03-PP	950801610			
NPN				S8-PR-5-U03-NN	950801620			
PLASTIC ABS			pig-tail	pig-tail	pig-tail	PNP/NPN/Push Pull 	S8-PR-5-U03-OZ	950800007
						PNP	S8-PR-3-U03-PP	950801710
						NPN	S8-PR-3-U03-NN	950801720

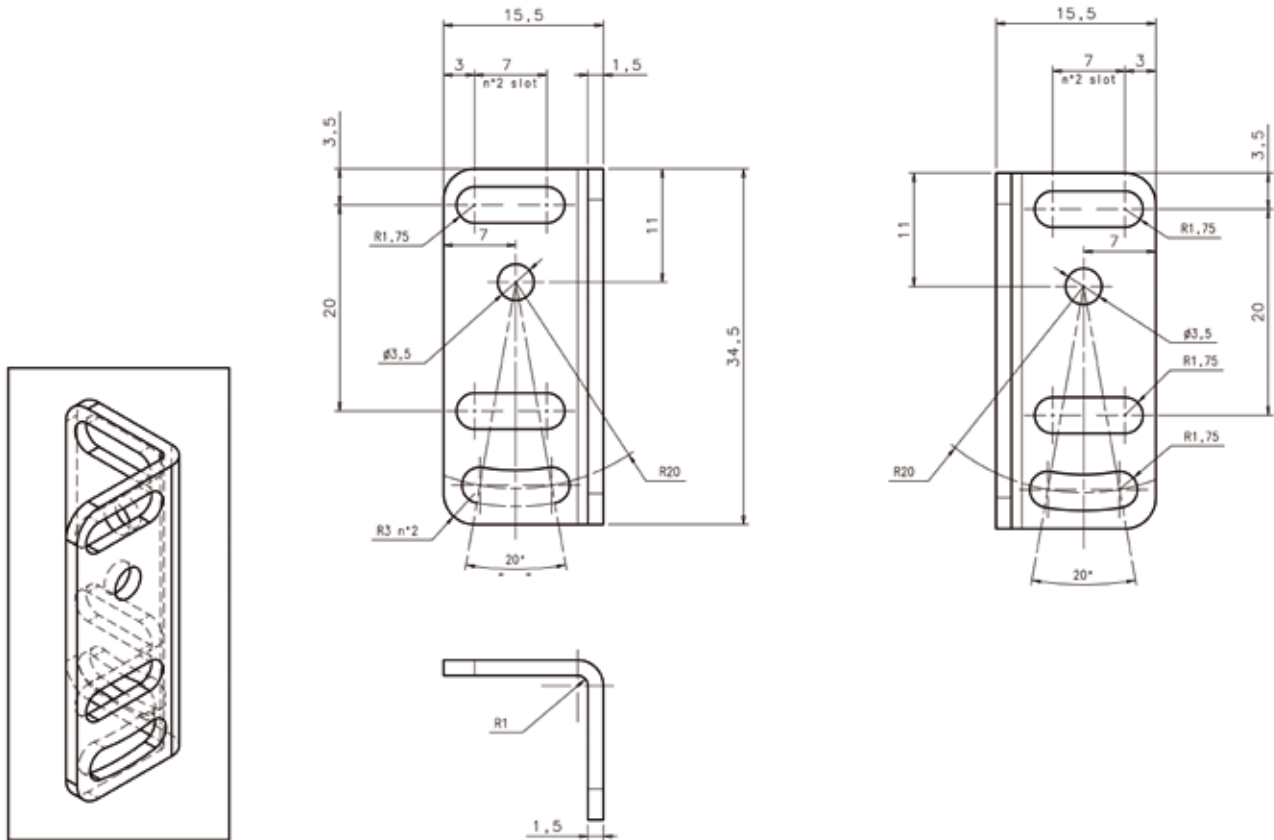

MODEL	FUNCTION	ORDER No.
ST-S8-FRM	mounting bracket for standard frame	95ACC7860
ST-5072	mounting bracket	95ACC1470
R4K	IP69K plastic reflector 51 x 61 mm	95A151220
ST-S8-TL-LD46	TL-LD46 adapting bracket	95ACC3430
ST-S8-S3Z	S8-miniature sensors adapting bracket	95ACC3440
ST-0387	Adapter bracket S8/S41	95ACC3410

IO-LINK CONNECTIVITY

MODEL	DESCRIPTION	ORDER No.
CBX-8IOL-EIP	CBX-8IOL-EIP 8P IOL M12 EIP MASTER	95ACC8180
CBX-8IOL-PNIO	CBX-8IOL-PNIO 8P IOL M12 PROFINET MASTER	95ACC8190

CABLES

TYPE	DESCRIPTION	LENGTH	MODEL	ORDER No.
Axial M8 Connector	4-pole, grey, P.V.C.	3 m	CS-B1-02-G-03	95A251420
		5 m	CS-B1-02-G-05	95A251430
		7 m	CS-B1-02-G-07	95A251440
		10 m	CS-B1-02-G-10	95A251480
	4-pole, P.U.R.	2 m	CS-B1-02-R-02	95A251620
		5 m	CS-B1-02-R-05	95A251640
Radial M8 Connector	4-pole, grey, P.V.C.	3 m	CS-B2-02-G-03	95A251450
		5 m	CS-B2-02-G-05	95A251460
		7 m	CS-B2-02-G-07	95A251470
		10 m	CS-B2-02-G-10	95A251530
	4-pole, P.U.R.	2 m	CS-B2-02-R-02	95A251630
		5 m	CS-B2-02-R-05	95A251650
Axial M12-M/M8-F Double Headed Connector	4-pole, PVC IO-Link	3 m	CS-H1-02-B-03	95ACC0008



S8-PR...M

Background suppression



S8-PR...B

Polarised retroreflex



S8-PR...C

Diffuse proximity



S8-PR...F/G

Receiver/Emitter

INSTRUCTION MANUAL

CONTROLS

OUTPUT LED (yellow) (S8...B/C/M/F)

The yellow LED ON indicates the output status.

POWER ON LED (green)

The green LED ON indicates the powering status and the laser emission presence.

DISTANCE ADJUSTMENT TRIMMER (ADJ.) (S8...M)

The multiturn trimmer with clutch (8 turns) adjusts the suppression distance through the mechanical variation of the optic triangulation angle.

The operating distance increases rotating the trimmer in a clockwise direction. Please refer to "SETTING" paragraph for the correct use procedure.

SENSITIVITY TRIMMER (ADJ.) (S8..B/C/F)

The sensitivity and operating distance can be adjusted using this trimmer.

See the "SETTING" paragraph for procedure indications.

LIGHT/DARK TRIMMER

The light/dark mode is selected using a mono-turn trimmer.

Please refer to "SETTING" paragraph for the correct use procedure.

WARNING: the maximum mechanical rotation range of the trimmer is 240°.

Do not force over of the maximum and minimum positions.

INSTALLATION

The sensor can be positioned by means of the two housing holes using two screws (M3x18 or longer, 0.8Nm maximum tightening torque) with washers.

Various orientable fixing brackets to ease the sensor positioning are available (please refer to the accessories listed in the general catalogue).

The operating distance is measured from the front surface of the sensor optics.



CONNECTIONS

M8 Connector

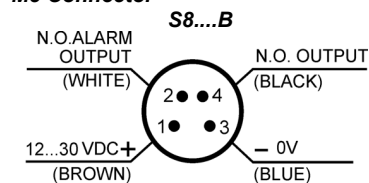

S8...M/C/F

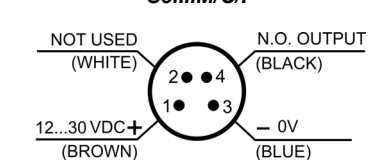

S8...G

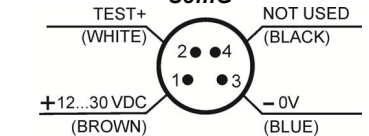

Pig-tail with M12 connector

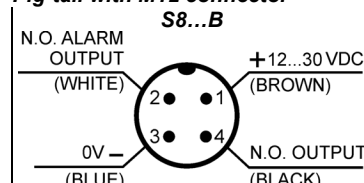

S8...M/C/F

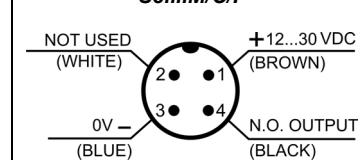

S8...G

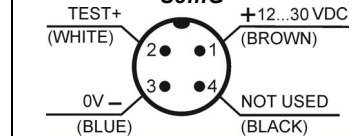

TECHNICAL DATA

	S8...M	S8...B	S8...C	S8...F	S8...G
Power supply:	12 ... 30 VDC				
Ripple:	2 Vpp max.				
Consumption (output current excluded):	35 mA max	30 mA max	20 mA max	15 mA max	
Outputs / Alarm output (only B):	PNP or NPN N.O.; 30 Vdc max. (short-circuit protection)				-
Output current:	100 mA (overload protection)				-
Output saturation voltage:	≤ 2 V				
Response time:	1ms	500 us			
Switching frequency:	500Hz	1KHz			
Emission type:	RED (660 nm)			-	RED (660 nm)
Operating distance (typical values):	50...300mm	5m on R2, 7m on R5 (EG2)	50cm on 90% white target (EG2)	25m (30m max)	
Regulations	8-turn distance adjustment trimmer	Mono-turn sensitivity adjustment trimmer			-
LIGHT/DARK selection:	Monoturn trimmer				-
Indicators:	OUTPUT LED (yellow) / POWER ON LED (green)			POWER ON LED (green)	
Operating temperature:	-10 ... 55 °C				
Storage temperature:	-20 ... 70 °C				
Dielectric strength:	□: 1500 Vac 1 min. between electronics and housing				
Insulating resistance:	>20 MΩ 500 Vdc between electronics and housing				
Ambient light rejection:	according to EN 60947-5-2				
Vibrations:	0.5 mm amplitude, 10 ... 55 Hz frequency, for each axis (EN60068-2-6)				
Shock resistance:	11 ms (30 G) 6 shocks for each axis (EN60068-2-27)				
Housing material:	ABS				
Lens material:	Window in glass; lens in PC				
Mechanical protection:	IP67				
Connections:	M8 4-pole connector / cable with M12 4-pole connector with 150 mm length and Ø 4 mm (pig-tail)				
Weight:	12 g. max. connector version / 50 g. pig-tail version				

SETTINGS

DARK/LIGHT SETTING

Rotate trimmer in an anti-clockwise direction to set the LIGHT mode (output ON with the reflector).

Rotate trimmer in a clockwise direction to set the DARK mode (output ON in presence of the object).

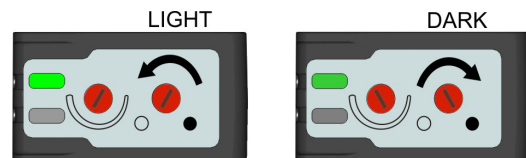

SUPPRESSION DISTANCE SETTING (S8...M)

1. Object detection (Light mode)

Position object to detect in front of the sensor at the distance required. Turn distance adjustment trimmer (ADJ) to minimum: yellow LED OFF.

Rotate trimmer in a clockwise direction until the yellow LED turns ON.

Object detection condition (pos.A).

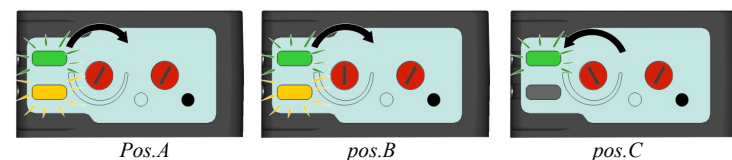

2. Background suppression

Remove object and ensure that the background is in front of the sensor: yellow LED OFF.

Rotate trimmer in a clockwise direction until the yellow LED turns ON: background detection condition (pos.B).

The trimmer reaches maximum level with yellow LED OFF if the background is outside the operating range.

Rotate trimmer in an anticlockwise direction until yellow LED turns OFF: condition where background is outside operating range (pos.C).

3. Setting and control

Rotate trimmer in an anti-clockwise direction until the trimmer reaches an intermediate point between position A and C.

If position A and C are close to each other, leave trimmer on position C. The sensor is now ready to function correctly and in stable conditions.

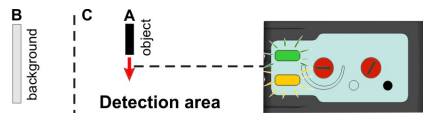

SENSITIVITY SETTING (S8...B)

Alignment:

- Position and align the sensor and reflector on opposite side at the desired distance.

- Rotate sensitivity adjustment trimmer (ADJ.) to maximum point (clockwise direction).

- Move the sensor vertically and horizontally to determine the powering on and powering off points of the yellow LED (OUT) and fix the sensor in the middle of these two points.

- To detect very small objects, reduce the sensitivity using the specific trimmer (if necessary). Repeat procedure reducing progressively the sensitivity to improve alignment.

Control:

- Enter object laterally in the detection area and check that the yellow LED turns ON (in dark mode).

- remove object and check that the yellow LED turns OFF immediately (in dark mode).

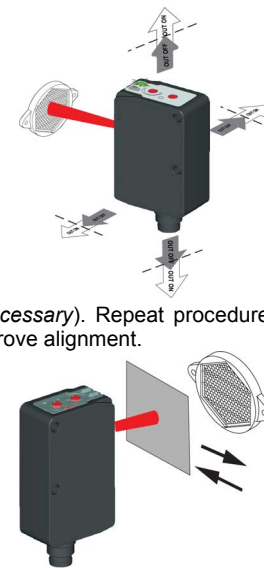

SETTINGS (S8...C)

Turn the sensitivity trimmer to minimum: the yellow LED is OFF (light mode). Position the target to detect in front of the sensor.

Turn the sensitivity trimmer clockwise until the yellow LED turns ON (Target detected state, pos.A).

Remove the target, the yellow LED turns OFF.

Turn the sensitivity trimmer clockwise until the yellow LED turns ON (Background detected state, pos.B).

The trimmer reaches maximum if the background is not detected.

Turn the trimmer to the intermediate position C, between the two positions A and B.



SETTINGS (S8...F/G)

Position the sensors on opposite sides. Turn the sensitivity trimmer to maximum. Find the points where the yellow LED (OUT) is switched ON and OFF in both vertical and horizontal positions, and fix the sensor in the centre between these points. If necessary, reduce sensitivity using the trimmer, in order to detect very small targets. In order to improve alignment, repeat the procedure detailed above whilst progressively reducing the sensitivity.

DIMENSIONS

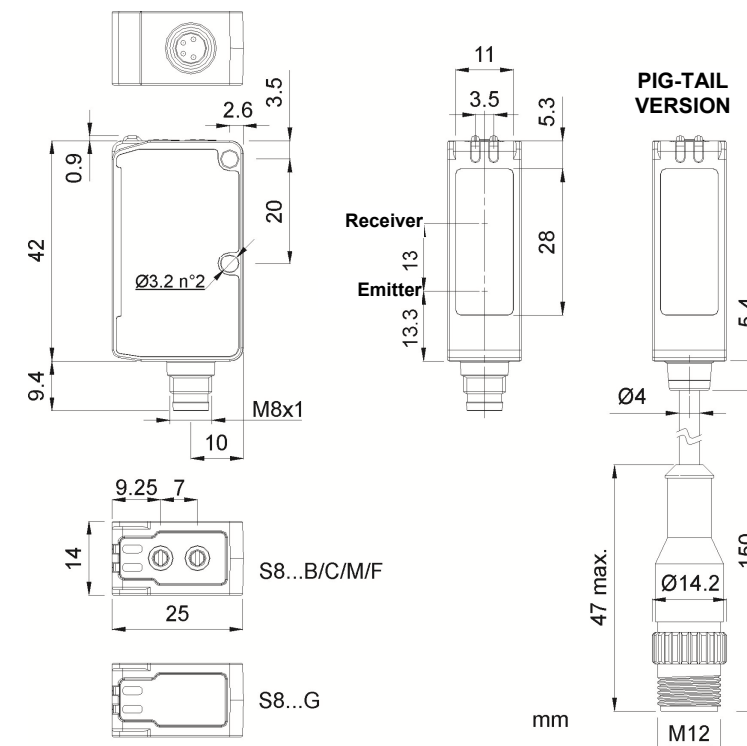

PERFORMANCES (S8..B)

TAB.1: Operative distance

REFLECTOR

R2	R5	RT3970 (60x40mm)
5 m	7 m	2 m

On RT3970 the sensor performances are strongly influenced by the dimensions used.

DETECTION DIAGRAM (S8...M)

Gray 18%/White 90% and black4%/White 90% difference

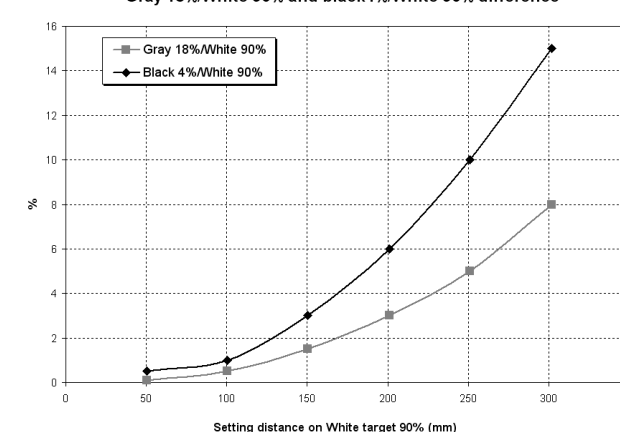

DIAGNOSTIC FUNCTIONS (S8...G)

TEST+ input

The TEST+ input can be used to inhibit the emitter and verify that the system is correctly operating. The TEST function is activated if the TEST+ input is connected to a voltage between 12...30V, whereas if the TEST+ input is connected to GND or it is not connected the function is deactivated.

Datalogic S.r.l.

Via S. Vitalino 13 - 40012 Calderara di Reno - Italy
Tel: +39 051 3147011 - Fax: +39 051 3147205 - www.datalogic.com

Helpful links at www.datalogic.com: [Contact Us](#), [Terms and Conditions](#), [Support](#).

The warranty period for this product is 36 months. See General Terms and Conditions of Sales for further details.

Under current Italian and European laws, Datalogic is not obliged to take care of product disposal at the end of its life. Datalogic recommends disposing of the product in compliance with local laws or contacting authorised waste collection centres.

© 2008 - 2017 Datalogic S.p.A. and/or its affiliates • ALL RIGHTS RESERVED. • Without limiting the rights under copyright, no part of this documentation may be reproduced, stored in or introduced into a retrieval system, or transmitted in any form or by any means, or for any purpose, without the express written permission of Datalogic S.p.A. and/or its affiliates. Datalogic and the Datalogic logo are registered trademarks of Datalogic S.p.A. in many countries, including the U.S.A. and the E.U. All other trademarks and brands are property of their respective owners. Datalogic reserves the right to make modifications and improvements without prior notification.