

S45



HIGH PERFORMANCE EUROPEAN STYLE MINIATURE SENSOR ALL-IN-ONE FAMILY



- Red LED and Laser emissions
- Precise risk free laser class 1 emission
- Diffused LED proximity 800mm
- Background Suppression 400mm
- Retroreflective Class 1 Laser 15m/Red LED 7m
- Through beam Class 1 Laser 20m/Red LED 15m
- IP69K housing
- 2m Cable or metal M8 4 pole version
- PNP or NPN output with remote teach in input
- High speed RGB and white emission contrast sensor
- High precision distance sensor up to 200 mm



APPLICATIONS

- Processing and Packaging machinery
- Cosmetic and Pharmaceutical industry
- Electronics assembling
- Conveyor lines, material handling
- Automotive industry
- Print and paper industry
- Small part detection with maximum accuracy

S45		
Through beam	20m. (Laser Class1) 15m. (Red Led)	
Polarized Retroreflective	15m. (Laser Class1) 7m. (Red Led)	
Autocollimated Retroreflective for Transparent objects	2m. (Red Led)	
Autocollimated Retroreflective	2m. (Red Led)	
Diffused proximity	250mm. (Laser Class1) 800mm. (Red Led)	
Background suppressor	120mm. (Laser Class 1) 200mm. (Red Led) 400mm. (Red Led)	
Distance sensor	80mm. (Red Led) 200mm. (Red Led)	
Contrast Sensor	12mm. (White) 12mm. (RGB)	
Power Supply	Vdc	10...30Vdc
	Vac	(13...30Vdc Y models)
	Vac/Vdc	
Output	PNP	•
	NPN	•
	NPN/PNP	
	relay	
	other	Push Pull (Wxx, Yxx), Analog 0...10 V (Yxx)
Connection	cable	•
	connector	•
	pig-tail	
Approximate dimensions (mm)	34mm. x 20mm. X 12mm.	
Housing material	ABS(Housing), PMMA (Optics)	
Mechanical protection	IP67 & IP69K	

TECHNICAL DATA

Power supply	10...30Vdc (13...30Vdc Y models)
Ripple	10% max.
Consumption (Load current excluded)	≤ 30 mA
Light emission	Red LED 632 nm, Red Laser 650 nm
Setting	Push Button TEACH-IN
Indicators	LED Green Operating Volatage LED Yellow Output Status
Output	NPN, PNP, Push Pull (Wxx, Yxx), Analog 0...10 V (Yxx)
Output current	100 mA
Saturation voltage	2 V max
Response time	500 μs 333 μs (C03 Laser) 250 μs (F/G Laser) 50 μs (W03, W33) 20 μs (W13, W43)
Switching frequency	≤ 1000Hz ≤ 1500Hz (C03 Laser) ≤ 2000 Hz (F/G Laser) ≤ 10 kHz (W03, W33) ≤ 25 kHz (W13, W43)
Connection	Plastic M8 4-pole connector, Metal M8 4-pole connector 2 m cable
Dielectric strength	500 Vac, 1min between electronic and housing
Insulating resistance	>20M OHM, 500 Vdc between electronic and housing
Electrical protection	class 2
Mechanical protection	IP67 & IP69K
Ambient light rejection	according to EN 60947-5-2
Vibrations	0,5mm amplitude, 10...55Hz frequency , for every axis (EN60068-2-6)
Shock resistance	11 ms (30G) 6 shock for every axis (EN60068-2-27)
Housing material	ABS
Lens material	PMMA
Operating temperature	-20...+60 °C
Storage temperature	-20...+80 °C
Weight	10g. with connector, 40g. with cable

DIMENSIONS

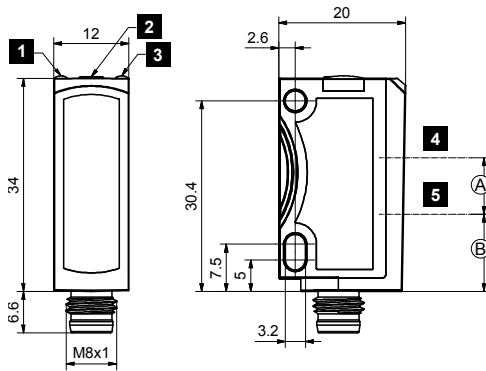

	S45-PR-2(5)-M03	S45-PR-2(5)-M13	S45-PR-2(5)-C03	S45-PH-5-M03	S45-PH-5-C03	S45-PR-G00	S45-PH-G00	S45-PR(PH)-F03
A	9	11.75	10.8	8.8	8.8	11.5	13.5	
B	12.3	11	11.5	12.5	13.5			22.3

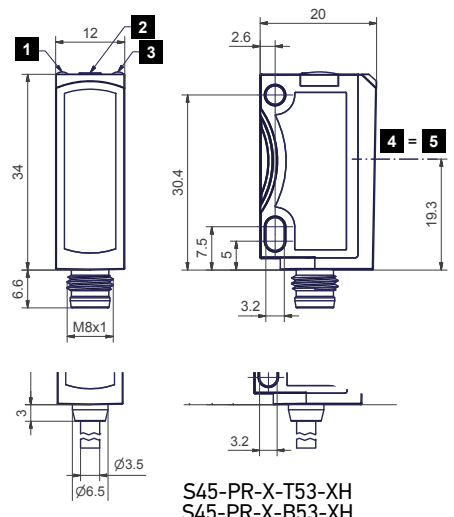
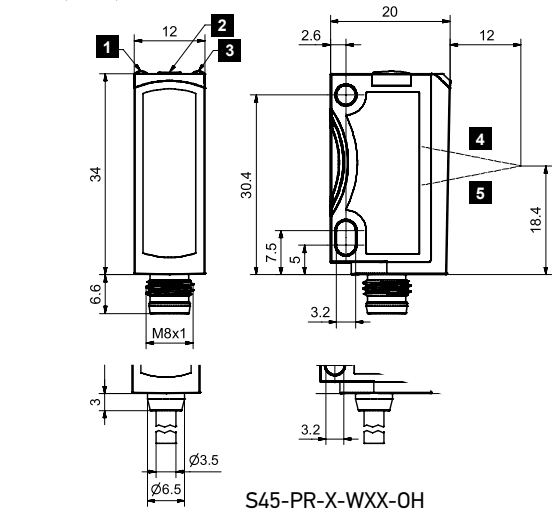

- 1 Yellow LED 1)
- 2 Button
- 3 Green LED 2)
- 4 Receiver axis
- 5 Emitter axis

1) switching output indicator
2) operating voltage indicator

CONNECTIONS

CABLE

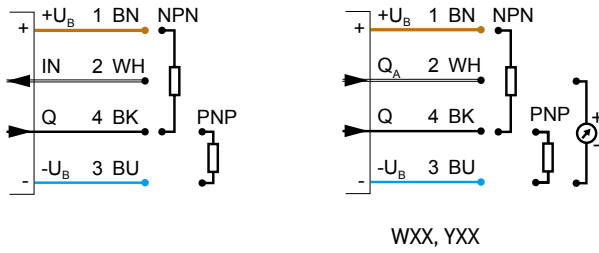

M8 CONNECTOR

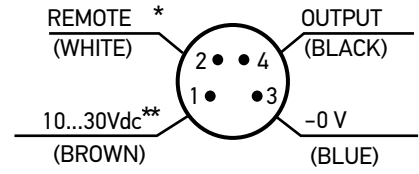

* Analog out YXX

** 13...30Vdc Y models

INDICATORS AND SETTINGS

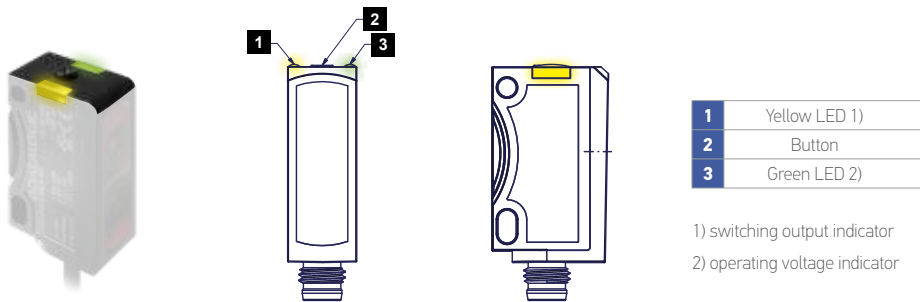

DETECTION DIAGRAMS

BACKGROUND SUPPRESSOR

DETECTION SPOT SIZE

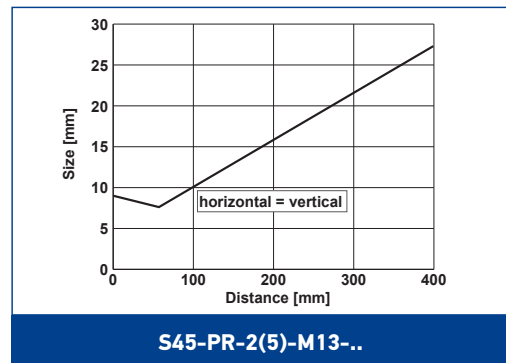
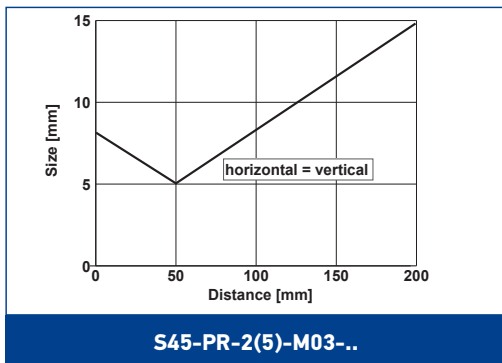

B/W SHIFT

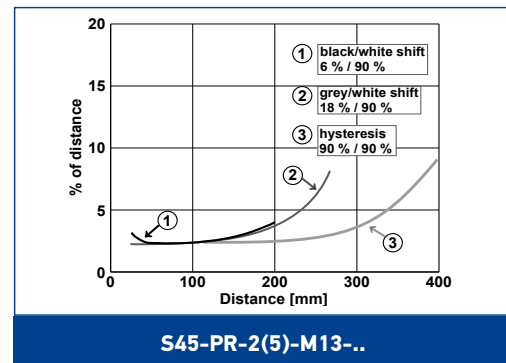
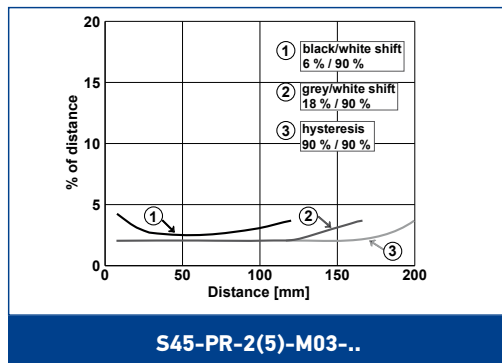

ENERGETIC DIFFUSED

DETECTION SPOT SIZE

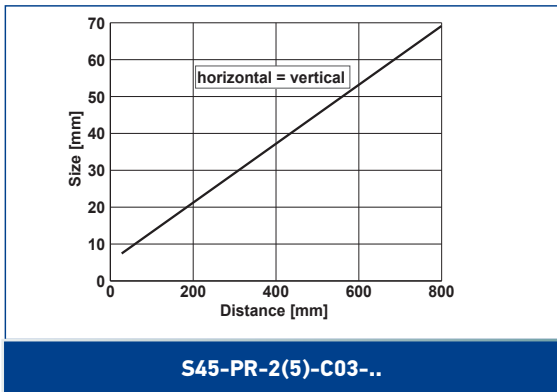

EXCESS GAIN

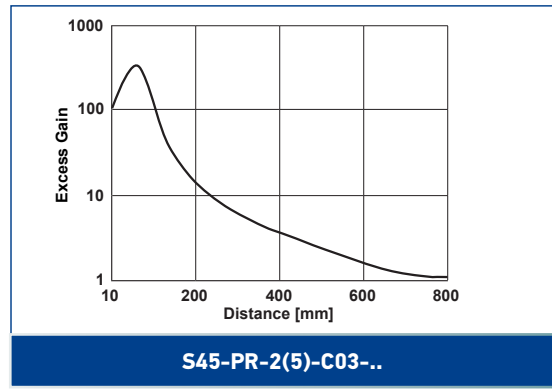

RETROREFLECTIVE POLARIZED

DETECTION SPOT SIZE

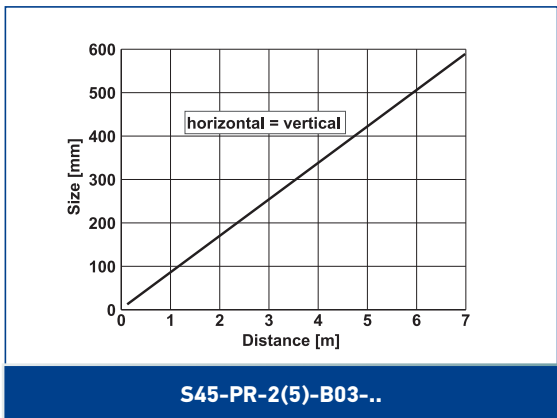

EXCESS GAIN

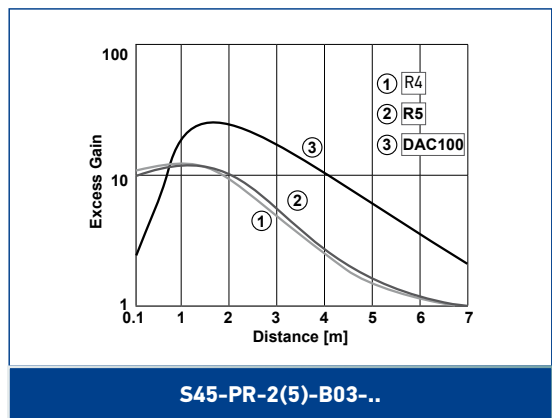

COAXIAL RETROREFLECTIVE POLARIZED

DETECTION SPOT SIZE

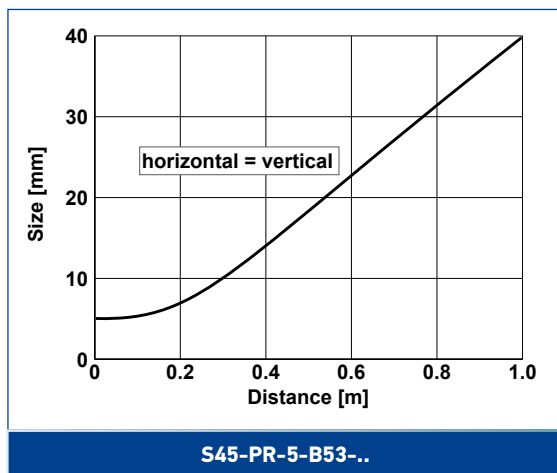

RETROREFLECTIVE FOR TRANSPARENT

DETECTION SPOT SIZE

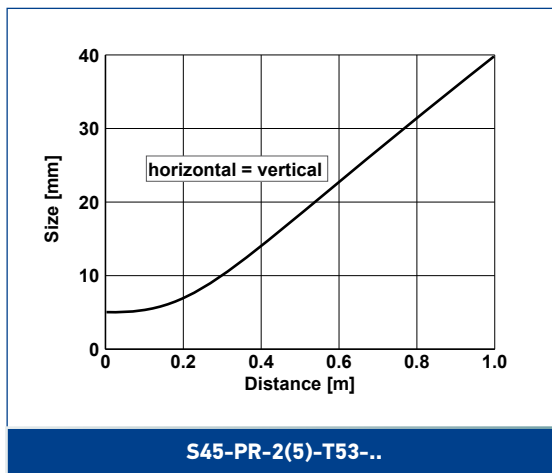

THROUGH BEAM

DETECTION SPOT SIZE

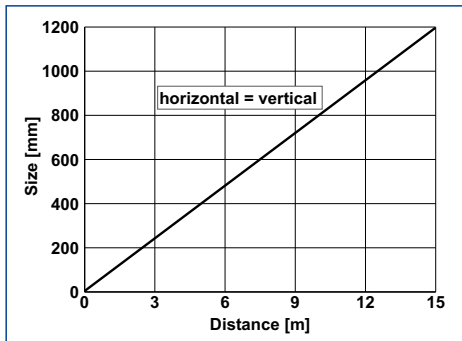

S45-PR-2(5)-F03-../S45-PR-2(5)-G00-XE

EXCESS GAIN

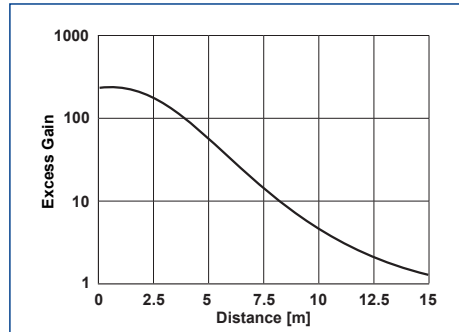

S45-PR-2(5)-F03-../S45-PR-2(5)-G00-XE

LASER BACKGROUND SUPPRESSOR

DETECTION SPOT SIZE

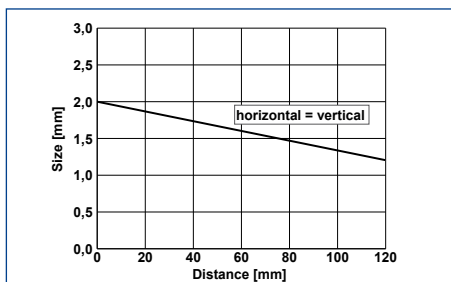

S45-PH-5-M03-..

B/W SHIFT

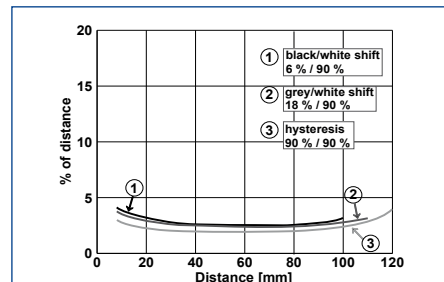

S45-PH-5-M03-..

LASER ENERGETIC DIFFUSED

DETECTION SPOT SIZE

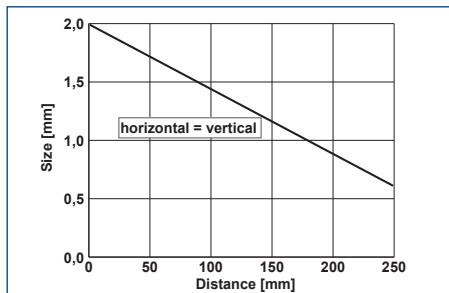

S45-PH-5-C03-..

EXCESS GAIN

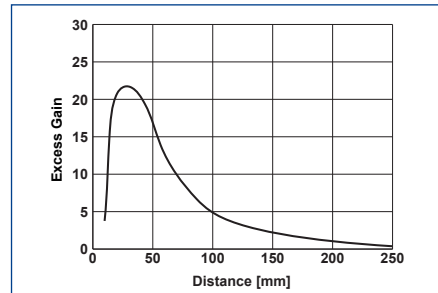

S45-PH-5-C03-..

LASER RETROREFLECTIVE POLARIZED

DETECTION SPOT SIZE

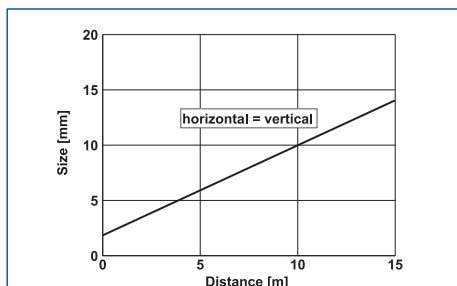

S45-PH-5-B03-..

EXCESS GAIN

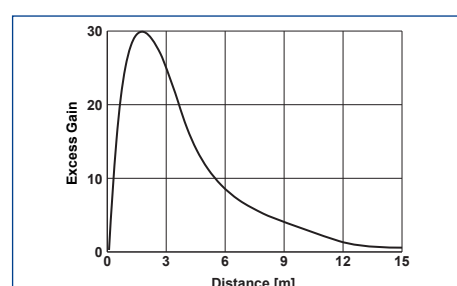

S45-PH-5-B03-..

LASER THROUGH BEAM

DETECTION SPOT SIZE

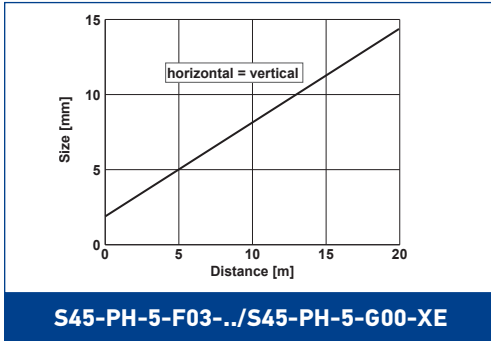

EXCESS GAIN

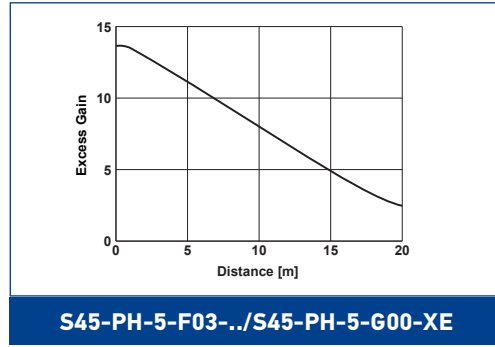

CONTRAST SENSOR

READING DIAGRAM

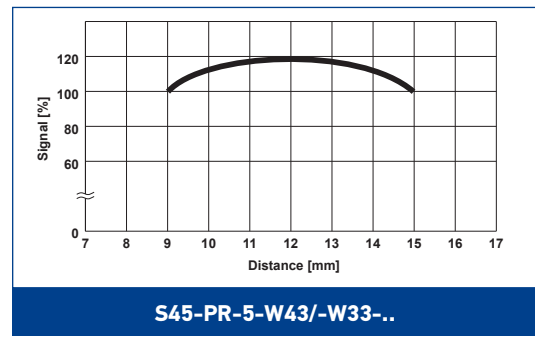
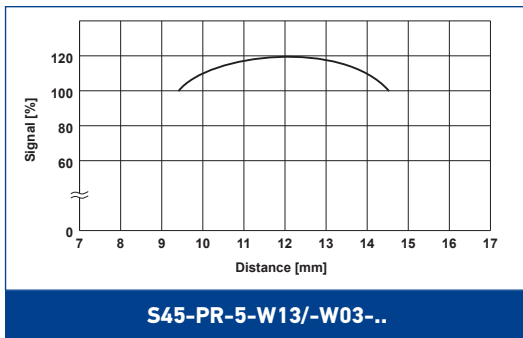

DISTANCE SENSOR

DETECTION SPOT SIZE

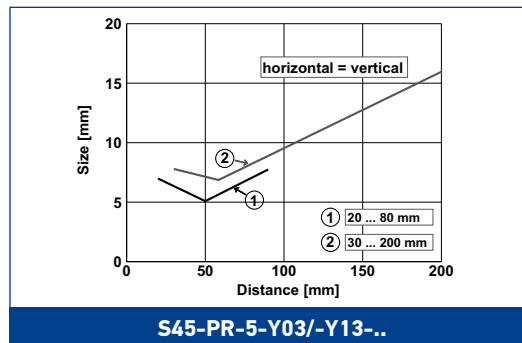

READING DIAGRAM

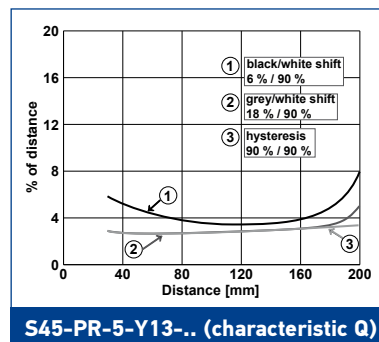
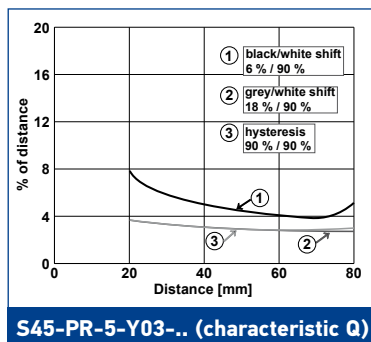

MODEL SELECTION AND ORDER INFORMATION

OPTIC FUNCTION	EMISSION	CONNECTION	OUTPUT	MODEL	ORDER NO.
Diffused proximity	LED	2m Cable	PNP	S45-PR-2-C03-PH	950411220
			NPN	S45-PR-2-C03-NH	950411210
		M8	PNP	S45-PR-5-C03-PH	950411240
			NPN	S45-PR-5-C03-NH	950411230
	LASER	M8	PNP	S45-PH-5-C03-PH	950411260
			NPN	S45-PH-5-C03-NH	950411250
Polarized Retroreflective	LED	2m Cable	PNP	S45-PR-2-B03-PH	950411100
			NPN	S45-PR-2-B03-NH	950411090
		M8	PNP	S45-PR-5-B03-PH	950411120
			NPN	S45-PR-5-B03-NH	950411110
	LASER	M8	PNP	S45-PH-5-B03-PH	950411140
			NPN	S45-PH-5-B03-NH	950411130
Polarized retroreflective autocollimated for transparent	LED	2m Cable	PNP	S45-PR-2-T53-PH	950411160
			NPN	S45-PR-2-T53-NH	950411150
		M8	PNP	S45-PR-5-T53-PH	950411180
			NPN	S45-PR-5-T53-NH	950411170
Polarized retroreflective autocollimated	LED	M8	PNP	S45-PR-5-B53-PH	950411200
			NPN	S45-PR-5-B53-NH	950411190
Through beam	LED	2m Cable	-	S45-PR-2-G00-XE	950411000
			PNP	S45-PR-2-F03-PH	950411020
			NPN	S45-PR-2-F03-NH	950411010
		M8	-	S45-PR-5-G00-XE	950411030
			PNP	S45-PR-5-F03-PH	950411050
			NPN	S45-PR-5-F03-NH	950411040
	LASER	M8	-	S45-PH-5-G00-XE	950411060
			PNP	S45-PH-5-F03-PH	950411080
			NPN	S45-PH-5-F03-NH	950411070
Background suppressor 200mm	LED	2m Cable	PNP	S45-PR-2-M03-PH	950411280
			NPN	S45-PR-2-M03-NH	950411270
		M8	PNP	S45-PR-5-M03-PH	950411300
			NPN	S45-PR-5-M03-NH	950411290
Background suppressor 400mm	LED	2m Cable	PNP	S45-PR-2-M13-PH	950411320
			NPN	S45-PR-2-M13-NH	950411310
		M8	PNP	S45-PR-5-M13-PH	950411340
			NPN	S45-PR-5-M13-NH	950411330
Background suppressor laser	LASER	M8	PNP	S45-PH-5-M03-PH	950411360
			NPN	S45-PH-5-M03-NH	950411350
Distance sensor	LED	M8	PNP	S45-PR-5-Y03-PV	950411380
			NPN	S45-PR-5-Y03-NV	950411370
Distance sensor	LED	M8	PNP	S45-PR-5-Y13-PV	950411400
			NPN	S45-PR-5-Y13-NV	950411390
Contrast Sensor 10kHz	WHITE	M8	PUSH-PULL	S45-PR-5-W03-OH	950411420
	RGB		PUSH-PULL	S45-PR-5-W13-OH	950411410
Contrast Sensor 25kHz	WHITE	M8	PUSH-PULL	S45-PR-5-W33-OH	950411440
	RGB		PUSH-PULL	S45-PR-5-W43-OH	950411430

ACCESSORIES

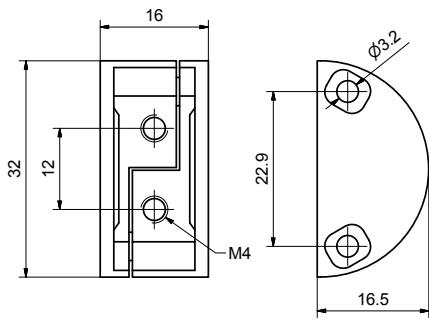

ST-S45-DVT

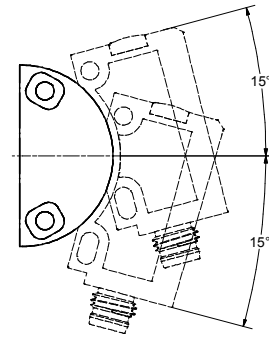

ST-S45-DVT

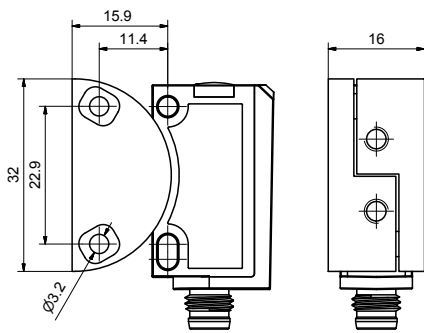

ST-S45-DVT

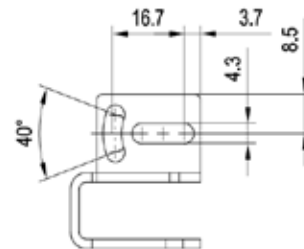
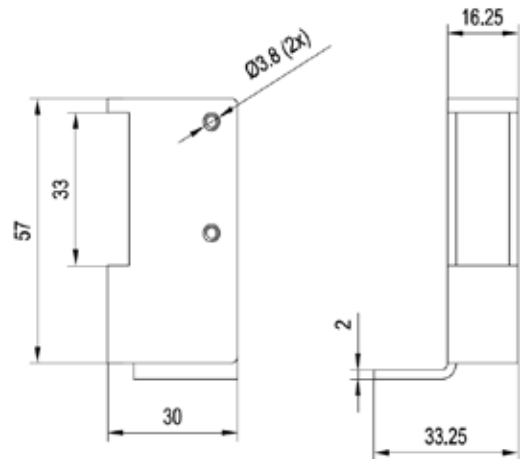

ST-MINI-PRO

MODEL	DESCRIPTION	ORDER NO.
ST-S45-DVT	S45 DOVE TAIL BRACKET	95ACC7970
ST-MINI-PRO	MINI PROTECTIVE BRACKET	95ACC7980

CABLES

TYPE	DESCRIPTION	LENGTH	MODEL	ORDER No.
Axial M8 Connector	4-pole, grey, P.V.C.	3 m	CS-B1-02-G-03	95A251420
		5 m	CS-B1-02-G-05	95A251430
		7 m	CS-B1-02-G-07	95A251440
		10 m	CS-B1-02-G-10	95A251480
	4-pole, P.U.R.	2 m	CS-B1-02-R-02	95A251620
		5 m	CS-B1-02-R-05	95A251640
Radial M8 Connector	4-pole, grey, P.V.C.	3 m	CS-B2-02-G-03	95A251450
		5 m	CS-B2-02-G-05	95A251460
		7 m	CS-B2-02-G-07	95A251470
		10 m	CS-B2-02-G-10	95A251530
	4-pole, P.U.R.	2 m	CS-B2-02-R-02	95A251630
		5 m	CS-B2-02-R-05	95A251650

Rev. 01, 07/2016



S45-...-T53* S45-...-B53

Barriera a riflessione ottica coassiale
Retro-reflective light barrier with auto-collimation principle
Barrière optique sur réflecteur avec principe d'autocollimation
Reflexionslichtschranke mit Autokollimationsprinzip

- * ⊕ per oggetti trasparenti
- * ⊕ for transparent objects
- * ⊕ pour des objets transparents
- * ⊕ für transparente Objekte



821003880 Rev.02 X1641
www.datalogic.com

DATI TECNICI | TECHNICAL DATA | DONNÉES TECHNIQUES | TECHNISCHE DATEN (TYP.)

S45		S45-PR-2-T53-PH ^{A)} S45-PR-5-T53-PH ^{A)}		S45-PR-2-T53-NH ^{A)} S45-PR-5-T53-NH ^{A)}		S45-PR-5-B53-PH		S45-PR-5-B53-NH	
Ⓛ	Ⓜ	Ⓧ	Ⓨ	Ⓩ	ⓐ	ⓑ	ⓓ	ⓔ	ⓕ
Uscita di commutazione Q	Switching output Q	Sortie de commutation Q	Schaltausgang Q	PNP	PNP	NPN	PNP	PNP	NPN
Distanza Operativa (RW) ³⁾	Operating range (RW) ³⁾	Portée (RW) ³⁾	Betriebsreichweite (RW) ³⁾	0,5 ... 2 m					
Tipo di emissione	Used light	Type de lumière	Lichtart	632 nm, LED rosso red rouge rot					
Dimensione dello spot	Size of light spot	Taille du spot de détection	Lichtfleckgröße	vedere grafici sul retro see back voir verso s. Rückseite					
Tensione di alimentazione +V ⁴⁾	Operating voltage +V ⁴⁾	Tension d'alimentation +V ⁴⁾	Betriebsspannung +V ⁴⁾	10 ... 30 V DC					
Corrente di assorbimento I ₀	No-load supply current I ₀	Courant hors charge I ₀	Leerlaufstrom I ₀	≤ 30 mA					
Corrente di uscita I _o	Output current I _o	Courant de sortie I _o	Ausgangsstrom I _o	≤ 100 mA					
Ingresso di Teach in IN ⁵⁾	Control input IN ⁵⁾	Entrée de contrôle IN ⁵⁾	Steuereingang IN ⁵⁾	+V = Teach in / -V = / non connesso = funzionamento normale					
Frequenza operativa (ti/tp 1:1)	Switching frequency (ti/tp 1:1)	Fréquence de commutation (ti/tp 1:1)	Schaltfrequenz (ti/tp 1:1)	≤ 1000 Hz					
Grado di protezione ⁶⁾	Enclosure rating ⁶⁾	Degré de protection ⁶⁾	Schutzart ⁶⁾	IP 67 / IP 69K					
Temperatura di funzionamento ²⁾	Ambient air temperature: operation ²⁾	Température ambiante: fonctionnement ²⁾	Umgebungstemperatur: Betrieb ²⁾	-20 ... +60 °C					
Temperatura di immagazzinamento	Ambient air temperature: storage	Température ambiante: stockage	Umgebungstemperatur: Lager	-20 ... +80 °C					
Peso con connettore / con cavo	Weight plug/cable	Poids Capteur avec connecteur /-câble	Gewicht Stecker-/Kabelgerät	10 g / 40 g					
Configurazione di fabbrica	Factory setting	Configuration d'origine	Werkseinstellung	max. RW, N.O.					

¹⁾ ⊕ eccetto i tipi: S45-PR-5-T53, S45-PR-5-B53
²⁾ UL: -20 ... +50 °C
³⁾ Riflettore utilizzato R4
⁴⁾ massima variazione residua del 10% della tensione di alimentazione, ~50Hz/100Hz
⁵⁾ vedere il grafico I; sul retro
⁶⁾ con connettore inserito IP 67 / IP 69K

¹⁾ ⊕ except for types S45-PR-5-T53, S45-PR-5-B53
²⁾ UL: -20 ... +50 °C
³⁾ Reference material reflector R4
⁴⁾ max. residual ripple 10%, within U_B, approx. 50Hz/100Hz
⁵⁾ see illustration I; back
⁶⁾ with connected IP 67 / IP 69K plug

¹⁾ ⊕ sauf les types S45-PR-5-T53, S45-PR-5-B53
²⁾ UL: -20 ... +50 °C
³⁾ Matériau de référence réflecteur R4
⁴⁾ Ondulation résiduelle maxi 10 % à l'intérieur de U_B, env. 50Hz/100Hz
⁵⁾ voir illustration I; verso
⁶⁾ avec connecteur IP 67 / IP 69K raccordé

¹⁾ ⊕ ausgenommen Typen S45-PR-5-T53, S45-PR-5-B53
²⁾ UL: -20 ... +50 °C
³⁾ Bezugsmaterial Reflektor R4
⁴⁾ max. 10% Restwertigkeit, innerhalb U_B, ~50Hz/100Hz
⁵⁾ siehe Grafik I; Rückseite
⁶⁾ mit angeschlossenem IP 67 / IP 69K Stecker

^{A)} ⊕ Con auto regolazione della soglia di commutazione
^{A)} ⊕ Switching threshold control
^{A)} ⊕ Poursuite du seuil de commutation
^{A)} ⊕ mit Schaltschwellen-nachführung

= Tasto bloccato
 = button locked
 = bouton verrouillée
 = Taste verriegelt

INDICAZIONI SDI SICUREZZA

Leggere attentamente le istruzioni prima della messa in servizio del sensore.

Connessione, Montaggio e messa in servizio devono essere eseguite da personale qualificato.

Non è un dispositivo di sicurezza in accordo con la direttiva macchine EU (non deve essere utilizzato per la protezione delle persone).

Non utilizzare in ambiente esterno.

Per l'uso dei sensori con connettore: Connettore M8 metallico dritto o 90° Zoccolo di connessione R/C (CYJV2).

ATTENZIONE - tutto ciò che riguarda l'utilizzo nel controllo o regolazione eseguito diversamente da quanto descritto in questo manuale può provocare una esposizione pericolosa alla radiazione del laser.

USO CORRETTO

Il Sensore deve essere utilizzato per la rilevazione di oggetto trasparenti e non trasparenti.

MONTAGGIO

Montare ed allineare correttamente il sensore ed il riflettore utilizzando i relativi accessori (vedere il sito www.datalogic.com).

CONNESSIONE

Inserire il connettore senza alimentazione ed avvertirlo fino in fondo.

Connettere il cavo come in figura B.

Vedere figura C per connessione PNP/NPN.

Tensione presente → LED Verde acceso.

Logica di uscita N.O. ↔ N.C. (vedi figura H sul retro).

N.O. Normalmente Aperto; N.C. Normalmente Chiuso.

POSIZIONAMENTO (VEDI FIGURA D)

Allineare il sensore al relativo riflettore (per esempio R4) fino a che il LED giallo non si spegne.

SAFETY INSTRUCTIONS

Read operating instructions before start-up.

Connection, assembly, setting and start-up only by trained personnel.

No safety component according to EU machinery directives (not suited for the protection of personnel).

Not for outdoor use.

For use with sensors with connector: Straight or L-shaped M8 metal connector, connector base is made of R/C (CYJV2).

CAUTION - Use of Controls or adjustments or performance of procedures other than those specified herein may result in hazardous radiation exposure.

INTENDED USE

Sensor is used for the optical non-contact detection of transparent and non-transparent objects.

ASSEMBLY

Attach the sensor and reflector to a suitable fixture (bracket see www.datalogic.com).

CONNECTION

Insert plug tension-free and screw it tightly.

Connect cable according to the connection diagram (see illustration B).

For PNP/NPN (see illustration C).

Apply voltage → green LED lights up.

Switching N.O. ↔ N.C. (see illustration H; back).

N.O. = normally open; N.C. = normally closed.

ADJUSTMENT (SEE ILLUSTRATION D)

Align sensor to suitable reflector (e.g. R4) until yellow LED goes off.

INSTRUCTIONS DE SÉCURITÉ

Lire les instructions de service avant mise en service.

Raccordement, assemblage, réglage et mise en service ne doivent être effectués que par du personnel qualifié.

Il ne s'agit pas de pièces de sécurité selon les directives européennes en vigueur concernant les machines (inapropriées à la protection de personnes).

Nepas utiliser à l'extérieur.

Pour une utilisation avec capteurs avec connecteur : Connecteur métallique M8 droit ou en forme de " L ", socle de raccordement en R/C (CYJV2).

ATTENTION - L'utilisation de commandes, de réglages ou de consignes autres que ceux spécifiés présente un risque d'exposition dangereuse aux radiations.

UTILISATION CONFORME

Le capteur est utilisé pour la détection optique des objets transparents et non transparents sans contact.

MONTAGE

Fixer le capteur et le réflecteur sur des supports adaptés (support voir www.datalogic.com).

RACCORDEMENT

Insérer le connecteur hors tension et visser.

Connecter le câble selon le schéma de raccordement (voir illustration B).

Pour PNP/NPN (voir illustration C).

Mettre sous tension → LED verte est allumée.

Inversion N.O. ↔ N.C. (voir illustration H ; verso).

N.O. = ouverture ; N.C. = fermeture.

AJUSTEMENT (VOIR ILLUSTRATION D)

Aligner le capteur sur un réflecteur approprié (p.ex. R4) jusqu'à ce que la LED jaune s'éteint.

SICHERHEITSHINWEISE

Vor Inbetriebnahme die Betriebsanleitung lesen.

Anschluss, Montage, Einstellung und Inbetriebnahme nur durch Fachpersonal.

Kein Sicherheitsbauteil gemäß EU-Maschinenrichtlinie (nicht zum Schutz von Personen geeignet).

Einsatz nicht im Aussenbereich.

Zur Verwendung mit Sensoren mit Stecker: Gerader oder L-förmiger M8 Metallstecker, Anschlusssockel aus R/C (CYJV2).

ACHTUNG - Durch Verwendung von Bedienelementen oder Einstellungen sowie Durchführung von Verfahren, die nicht hier angegeben sind, kann es zum Austritt gefährlicher Strahlung kommen.

BESTIMMUNGSGEMÄSSE VERWENDUNG

Sensor wird zum optischen berührungslosen Erfassen von transparenten und nicht transparenten Objekten eingesetzt.

MONTAGE

Stecker und Reflektor an geeigneten Haltern befestigen. (Halter s. www.datalogic.com)

ANSCHLUSS

Stecker spannungsfrei aufstecken und festschrauben.

Leitung anschliessen. Es gilt das Anschlusschema (s. Grafik B).

Für PNP/NPN gilt (s. Grafik C).

Spannung anlegen → LED grün leuchtet.

Umschaltung N.O. ↔ N.C. (s. Grafik H; Rückseite).

N.O. = Schließer; N.C. = Öffner.

JUSTAGE (S. GRAFIK D)

Sensor auf geeigneten Reflektor (z.B. R4) ausrichten bis gelbe LED erlischt.

A. DIMENSIONI DI INGOMBRO | DIMENSIONAL DRAWING | PLAN COTES | MASSBILD

Ⓛ	Ⓜ	Ⓧ	Ⓨ
1 LED Giallo ¹⁾	Yellow LED ¹⁾	LED jaune ¹⁾	LED gelb ¹⁾
2 Tasto	Button	Bouton	Taste
3 LED Verde ²⁾	Green LED ²⁾	LED verte ²⁾	LED grün ²⁾
4 Asse di ricezione	Receiver axis	Axe de récepteur	Empfängerachse
5 Asse di emissione	Emitter axis	Axe d'émetteur	Senderachse

¹⁾ Indicatore dello stato di uscita | switching output indicator
afficheur sortie de commutation | Schaltausgangsanzeige

²⁾ Indicatore della tensione di alimentazione attiva | operating voltage indicator
afficheur tension de service | Betriebsspannungsanzeige

B. CONNESSIONE | CONNECTION | RACCORDEMENT | ANSCHLUSS

S45	-	PR	-	2	-	T53	-	PH	Example
S45	-	xx	-	2	-	xxx	-	PH	4-pin
S45	-	xx	-	2	-	xxx	-	NH	
S45	-	xx	-	5	-	xxx	-	PH	
S45	-	xx	-	5	-	xxx	-	NH	

2 is not available for B53

C. MODALITA' DI COMMUTAZIONE | SWITCHING MODE | TYPE DE COMMUTATION | SCHALTART

PNP		LED giallo
N.O.	+V	
N.O.	-V	
N.C.	+V	
N.C.	-V	
NPN		LED giallo
N.C.	+V	
N.C.	-V	
N.O.	+V	
N.O.	-V	

D. POSIZIONAMENTO | ADJUSTMENT | AJUSTEMENT | JUSTAGE

① CONFIGURAZIONE

Il sensore ha tre differenti metodi di regolazione.
Doppio apprendimento del riflettore (RTI): utilizzato per rilevazione di oggetti trasparenti. La regolazione viene eseguita apprendendo 2 volte il riflettore (vedere figura E).
S45-PR-x-T53: il controllo della soglia di commutazione è attivo.
Regolazione dinamica con Teach in (DTI): utilizzato per la maggior parte delle applicazioni. La regolazione viene eseguita durante il passaggio dell'oggetto in macchina (vedi figura F). Il riflettore deve essere completamente rilevato dal sensore almeno una volta durante il passaggio degli oggetti.
S45-PR-x-T53: il controllo della soglia di commutazione è attivo.
Regolazione Riflettore e oggetto con Teach in (ROTI): utilizzato per la rilevazione di oggetti non trasparenti. La regolazione viene effettuata acquisendo prima il riflettore poi l'oggetto (vedi figura G).
S45-PR-x-T53: il controllo della soglia di commutazione è disattivato.

MANUTENZIONE

Il sensore è libero da manutenzione.

② SETTING

The sensor has 3 different Teach-in modes.
Reflector-Reflector Teach-in (RTI): is suited for the detection of transparent objects. The setting is made 2x to the reflector. (see illustration E).
S45-PR-x-T53: Switching threshold control active.
Dynamic Teach-in (DTI): is suited for nearly all applications. The setting is performed during the running process (see illustration F). The reflector must be completely exposed to the beam route at least once.
S45-PR-x-T53: Switching threshold control active.
Reflector-Object Teach-in (ROTI): is suitable for the detection of non-transparent objects. The setting is made to the reflector and the object (see illustration G).
S45-PR-x-T53: Switching threshold control inactive.

MAINTENANCE

Sensors are maintenance-free. We recommend to cyclically clean the optical surfaces and check the screw connections and plug connections.

③ RÉGLAGE

Le capteur a 3 modes différents d'apprentissage (Teach-in).
Reflector-Reflector Teach-in (RTI) : est adapté à la détection d'objets transparents. L'alignement a lieu 2x sur le réflecteur (voir illustration E).
S45-PR-x-T53 : Poursuite du seuil de commutation activée.
Dynamic Teach-in (DTI) : est adapté à presque toutes les applications. L'alignement a lieu durant le processus (voir illustration F). Le chemin des rayons doit saisir le réflecteur au moins une fois dans son intégralité.
S45-PR-x-T53 : Poursuite du seuil de commutation activée.
Reflector-Object Teach-in (ROTI) : est adapté à la détection d'objets non transparents. L'alignement a lieu sur le réflecteur et sur l'objet (voir illustration G).
S45-PR-x-T53 : Poursuite du seuil de commutation inactivée.

ENTRETIEN

Les capteurs ne demandent aucun entretien. Nous recommandons de nettoyer les surfaces optiques et vérifier les raccordements et les fixations régulièrement.

④ EINSTELLUNG

Der Sensor verfügt über 3 unterschiedliche Teach-in-Modi.
Reflector-Reflector Teach-in (RTI): ist geeignet für die Detektion von transparenten Objekten. Einstellung erfolgt 2x auf den Reflektor (s. Grafik E).
S45-PR-x-T53: Schaltschwellennachführung aktiv.
Dynamic Teach-in (DTI): ist für nahezu jede Anwendung geeignet. Einstellung erfolgt im laufenden Prozess (s. Grafik F). Der Reflektor muß mindestens einmal komplett vom Strahlengang erfasst werden.
S45-PR-x-T53: Schaltschwellennachführung aktiv.
Reflector-Object Teach-in (ROTI): ist geeignet für die Detektion von nicht transparenten Objekten. Einstellung erfolgt auf den Reflektor und das Objekt (s. Grafik G).
S45-PR-x-T53: Schaltschwellennachführung inaktiv.

WARTUNG

Sensoren sind wartungsfrei. Es wird empfohlen in regelmäßigen Intervallen die optischen Flächen zu reinigen und Verschraubungen und Steckverbindungen zu überprüfen.

E. REFLECTOR-REFLECTOR TEACH-IN (RTI) | APPRENDIMENTO RIFLETTORE-RIFLETTORE

Step 1: Teach-in reflector / Apprendimento Riflettore

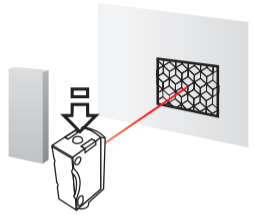

press > 3 s

until green & yellow LED flash at the same time /
fino a che il LED verde e giallo non lampeggiano assieme

Step 2: Teach-in object / Apprendimento oggetto

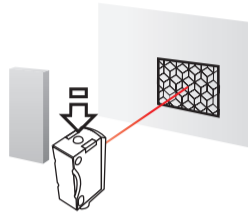

press > 1 s



External Teach-in / Teach in Esterno → I.

F. DYNAMIC TEACH-IN (DTI) | APPRENDIMENTO DINAMICO

Step 1: During running process / Durante il processo avviato

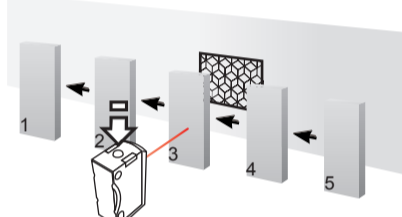

press > 3 s

until green & yellow LED flash at the same time /
fino a che il LED verde e giallo non lampeggiano assieme

Step 2: Teach-in object during running process / Apprendimento oggetto con processo avviato

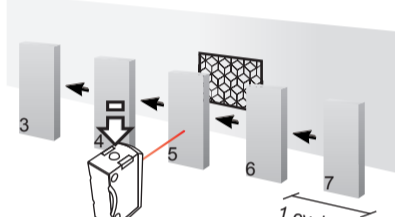

press > 1 cycle



External Teach-in / Teach in Esterno → I.

G. REFLECTOR-OBJECT TEACH-IN (ROTI) | APPRENDIMENTO RIFLETTORE-OGGETTO

Step 1: Teach-in reflector / Apprendimento riflettore

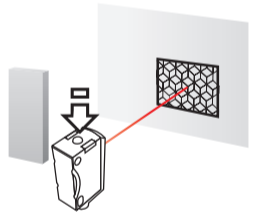

press > 3 s

until green & yellow LED flash at the same time /
fino a che il LED verde e giallo non lampeggiano assieme

Step 2: Teach-in object / Apprendimento oggetto

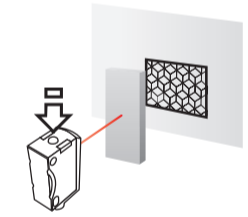

press > 1 s



External Teach-in / Teach in Esterno → I.

H. SELEZIONE N.O. / N.C. | SWITCHING N.O. / N.C. | INVERSION N.O. / N.C. | UMSCHALTUNG N.O. / N.C.

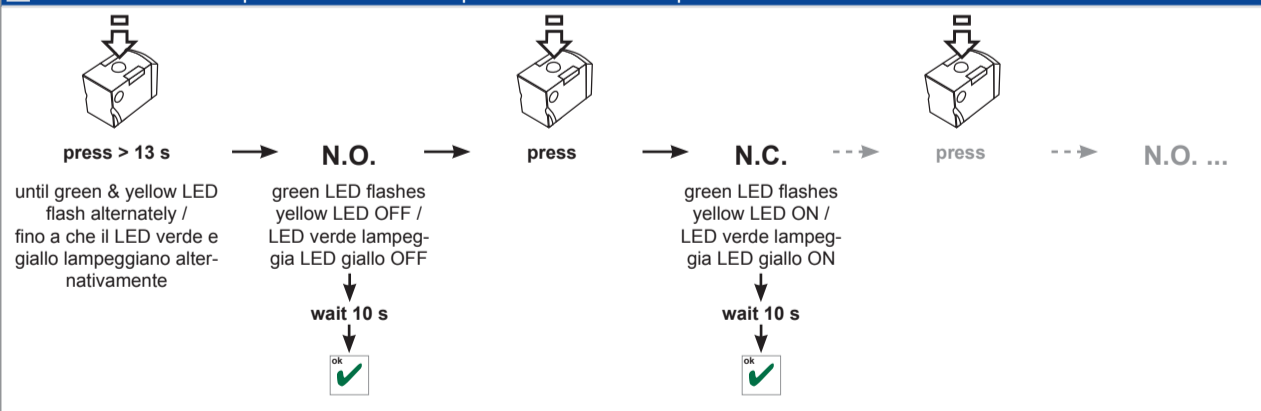

I. EXTERNAL TEACH-IN | TEACH IN ESTERNO

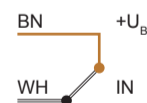

① **Regolazione con TEACH IN esterno:** Comandare l'ingresso con le stesse tempistiche del pulsante di teach in.

② **Setting via control input IN:** Closing and opening times according to the corresponding indications for the button.

③ **Réglage par entrée de contrôle IN :** Temps de fermeture et d'ouverture selon l'indication correspondante de la bouton.

④ **Einstellung über Steuereingang IN:** Schließ- und Öffnungsdauer analog den jeweiligen Angaben für die Taste.

DIMENSIONE DELLO SPOT | SIZE OF LIGHT SPOT | TAILLE DU SPOT DE DÉTECTION | LICHTFLECKGRÖSSE (TYP.)

S45-PR-2(5)-T53(B53)-..

