

S100

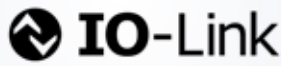

New ASIC



THE UNIVERSAL MINIATURE PHOTOELECTRIC SENSOR

- Two threaded front mounting holes
- Two slotted rear mounting holes
- Anti-tampering sensor (no adjustment)
- High speed high resolution RGB contrast sensor available
- Transparent object detection
- M8 connector and cable models
- PNP or NPN models with Light/Dark selection by wire
- Plastic housing, IP67 mechanical protection
- IO-Link COM2 communication protocol
- IO-Link V1.1.2 version
- IO-Link extended parametrization for monitoring and maintenance

APPLICATIONS

- Processing and packaging machines
- Conveyors
- Automatic warehousing
- Intralogistic lines
- Bottling
- Cosmetic and Pharma machinery
- Industry 4.0 application compliant

S100

Through beam		12 m
Retroreflective		7 m
Polarized Retroreflective (long range)		5,5 m
Polarized Retroreflective (short range)		3 m
Transparent Retroreflective (short range)		500 mm
Transparent Retroreflective (long range)		2 m
Diffused proximity (short range)		300 mm
Diffused proximity (long range)		500 mm
Fixed focus		70 mm
Background Suppression (short range)		100 mm
Background Suppression (long range)		200 mm
RGB Mark Reader		12,5mm+/-2mm
Power supply	Vdc	10...30 Vdc
Output	PNP	•
	NPN	•
Connectivity	IO-Link	IO-Link V1.1.2 Smart Sensor Profile Fully programmable double output stage through IO-Link parametrization
Connection	cable	2 m cable, 4 wires
	connector	M8 conn., 4-pole
Approximate dimensions (mm)		32x20x12
Housing material		Plastic
Mechanical protection		IP67

TECHNICAL DATA

Power supply	10 ... 30 Vdc
Ripple	10% max.
Consumption (output current excluded)	35 mA max. (mod. S100...W) 30 mA max. (mod. S100...B/M/ T IO-Link) red LED 632 nm (mod. S100...B/C/D/M01) IR LED 860 nm (mod. S100...A/G/Txx/M10) RGB LED (mod. S100-W00)
Light emission	1.5mm x 6.5mm (mod. S100-W00)
Spot size	remote teach-in (mod. S100...Mxx/Txx/W00)
Setting	LIGHT/DARK selectable by wire (mod. S100...A/B/C/D/F)
Operating mode	yellow OUTPUT LED (excl. mod. G) green POWER LED (mod. S100...G)
Indicators	PNP or NPN
Output	Fully programmable output stage only in IO-Link model Pin 2 I/O programmable only for IO-Link models
Output current	100 mA
IO-Link Connectivity	V1.1.2
IO-Link COM	COM2
IO-Link min cycle	2.3ms
Saturation voltage	2 V max.
Response time	2 ms (mod. S100...FG) 1 ms (mod. S100...A/Bxx/C/D/Mxx/Txx/T IO-Link), 500µs (B IO-Link), 25µs (W00-xx)
Switching frequency	250 Hz (mod. S100...FG) 500 Hz (mod. S100...A/Bxx/C/D/Mxx/Txx/T IO-Link), 1KHz (B IO-Link), 20kHz (W00-xx)
Jitter	13µs(W00-xx)
Connection	2 m cable Ø 3,5 mm, M8 4-pole connector
Dielectric strength	500 Vac, 1 min between electronics and housing
Insulating resistance	>20 MΩ, 500 Vdc between electronics and housing
Mechanical protection	IP67
Ambient light rejection	according to EN 60947-5-2
Vibrations	0,5 mm amplitude, 10 ... 55 Hz frequency, for every axis (EN60068-2-6)
Shock resistance	11 ms (30 G) 6 shock for every axis (EN60068-2-27)
Housing material	ABS body, PMMA indicators cover
Lens material	PC lens, PMMA window
Operating temperature	-25... 55 °C
Storage temperature	-40 ... 70 °C
Weight	50 g max. cable vers., 10 g max. connector vers.

DIMENSIONS

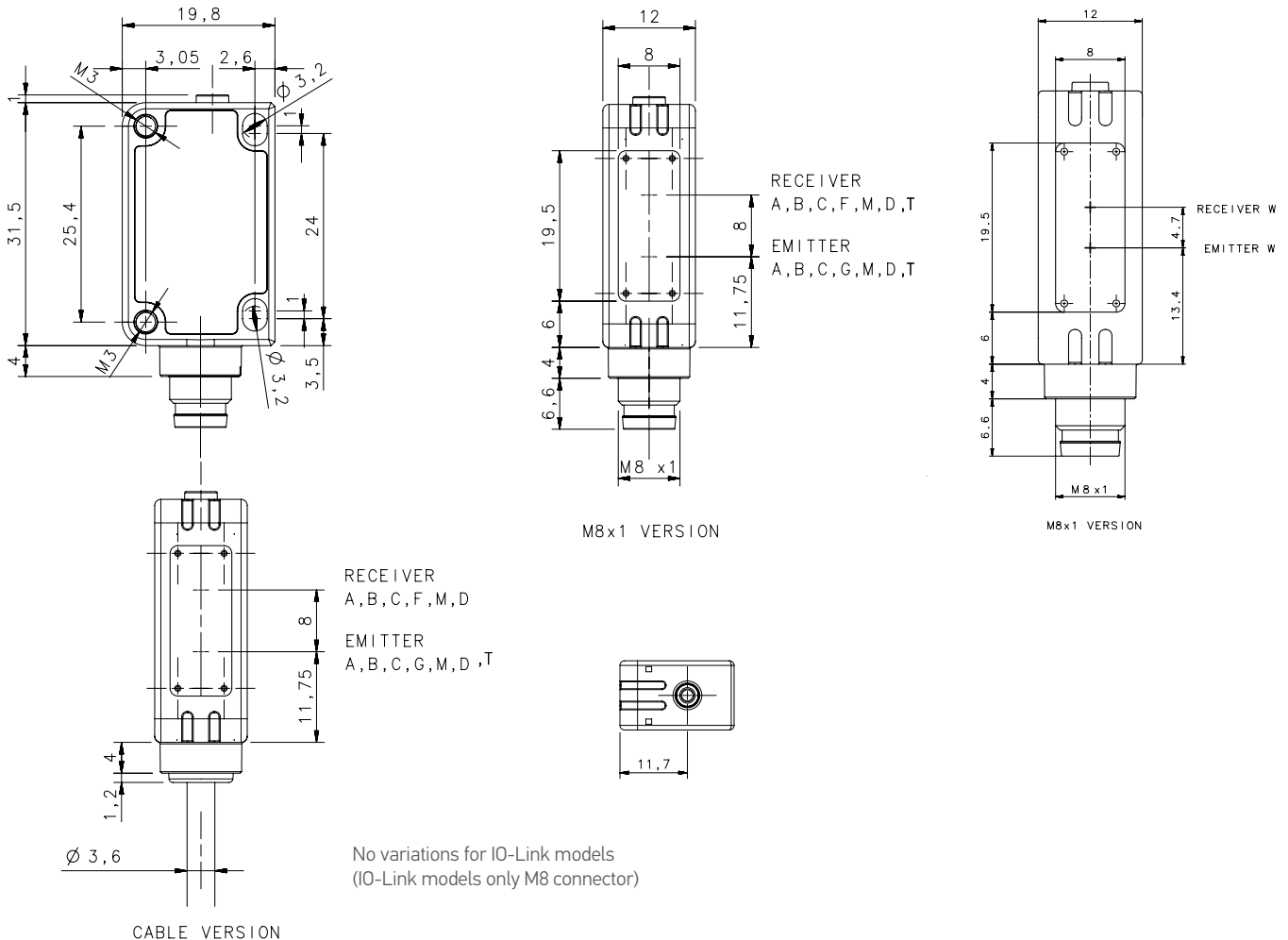

CONNECTIONS

M8 CONNECTOR

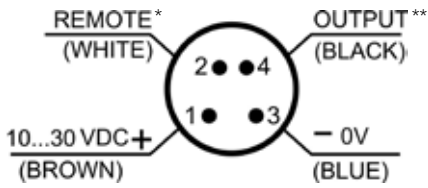

CABLE

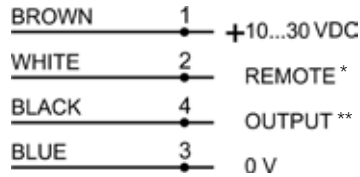

S100-PR-5-(B10, M10, T10, W00)-OZ

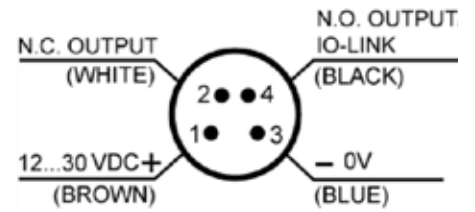

*REMOTE: Light/Dark selection (S100-...-A-B-C-D-F), External Teach-in (S100-...-Mxx/Txx/W00)
 **OUTPUT: PNP or NPN depends on the model

Pin 2 I/O programmable only for IO-Link models

INDICATORS AND SETTINGS

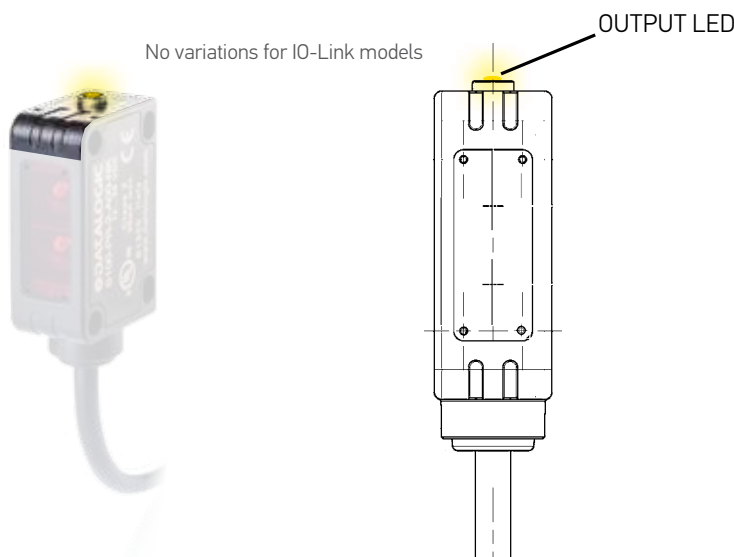

DETECTION DIAGRAMS

THROUGH BEAM

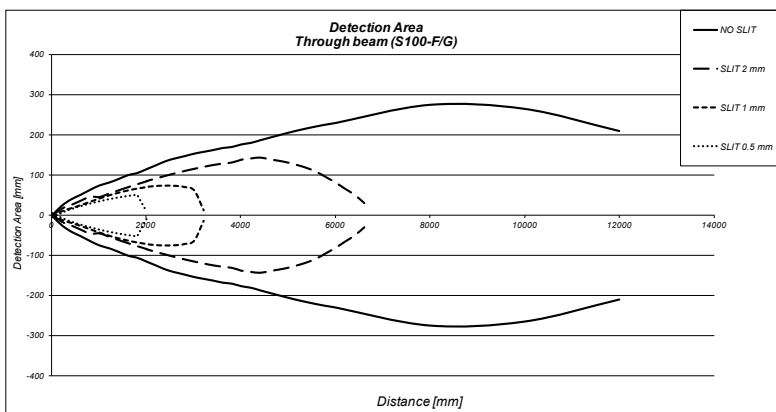

	max. operating distance
NO SLIT	12 m
2 mm SLIT	6,7 m
1 mm SLIT	3,2 m
0,5 mm SLIT	2 m

DIFFUSE PROXIMITY

	SHORT RANGE (S100-...-C0)	LONG RANGE (S100-...-C1)
Recommended operating distance (on White 90% target)	10...240 mm	2...400 mm
Maximum operating distance (White 90% target)	1...300 mm	0...500 mm
Maximum operating distance (Grey 18% target)	20...150 mm	10...280 mm
Maximum operating distance (Black 6% target)	30...80 mm	20...160 mm
Difference White-Grey	50%	50%
Difference White-Black	75%	75%
Hysteresis	20%	20%

DIFFUSE (SHORT RANGE: S100-C00)

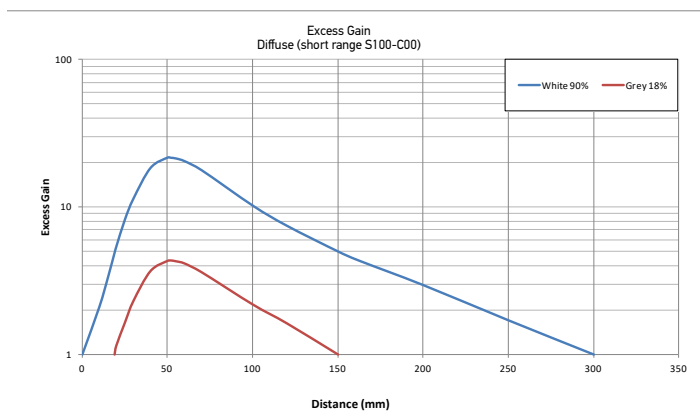
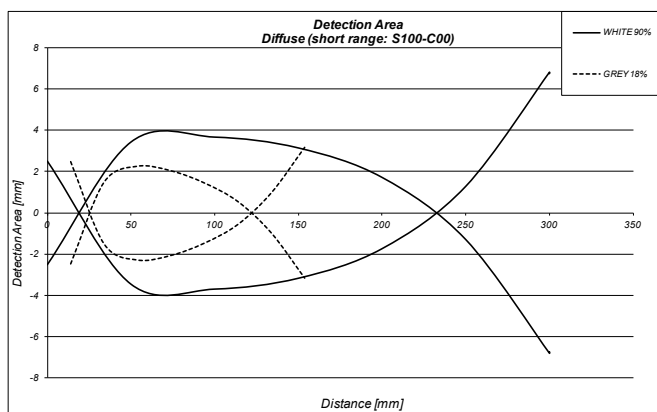

DIFFUSE (LONG RANGE: S100-C10)

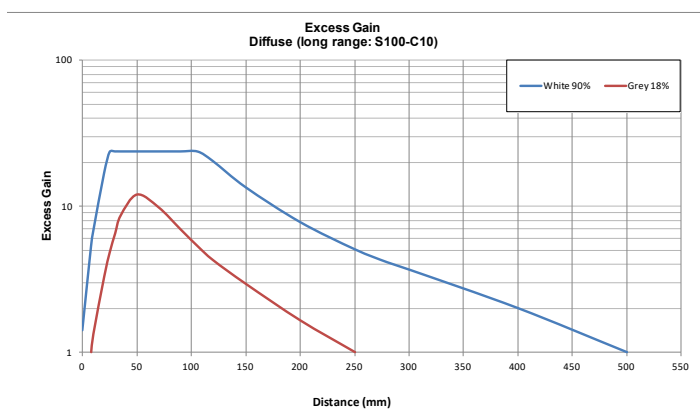
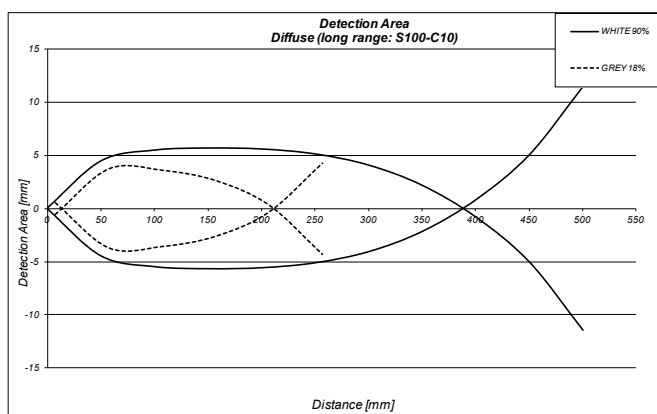

POLARIZED RETROREFLECTIVE

REFLECTOR	TYPE	SHORT RANGE (S100-...-B00)	LONG RANGE (S100-...-B10) IO-Link
R1	circular (23 mm)	0,2..0,8 m	0,02..2 m
R2	circular (48 mm)	0,03..2 m	0,01..4,5 m
R3	rectangular (18x54 mm)	0,03..1,5 m	0,01..3 m
R4	rectangular (47x47 mm)	0,03..2,5 m	0,01..4,5 m
R5	circular (75 mm)	0,01..3 m	0,01..5,5 m
R6	rectangular (36x55 mm)	0,03..1,8 m	0,01..4 m
RT3970	self-adhesive tape (60x40 mm)	0,2..0,8 m	0,05..1,8 m



	max. operating distance			
	SHORT RANGE (S100-...-B00)		LONG RANGE (S100-...-B10) IO-Link	
	with R5 reflector	with R2 reflector	with R5 reflector	with R2 reflector
NO SLIT	0,02 ... 3 m	0,02 ... 2 m	0,1...5,5 m	0,01...4,5 m
2 mm SLIT	0,05 ... 1,5 m	0,05 ... 0,8 m	0,2...4 m	0,03...3 m
1 mm SLIT	-	-	0,3...2,5 m	0,05...1,5 m
0,5 mm SLIT	-	-	0,5...1,2 m	0,07...0,7 m

POLARIZED RETROREFLECTIVE (SHORT RANGE: S100-B00)

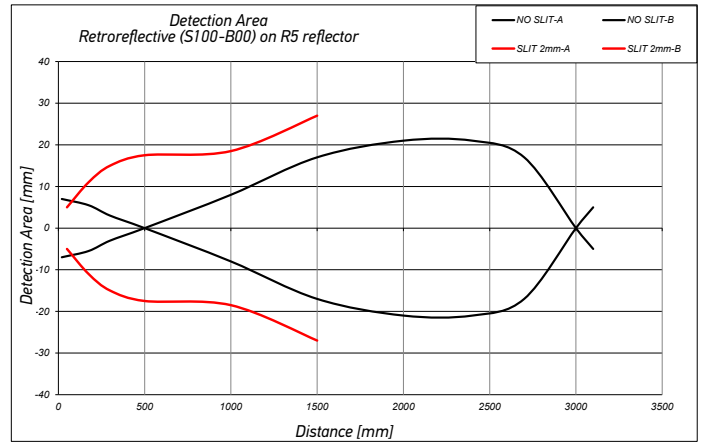
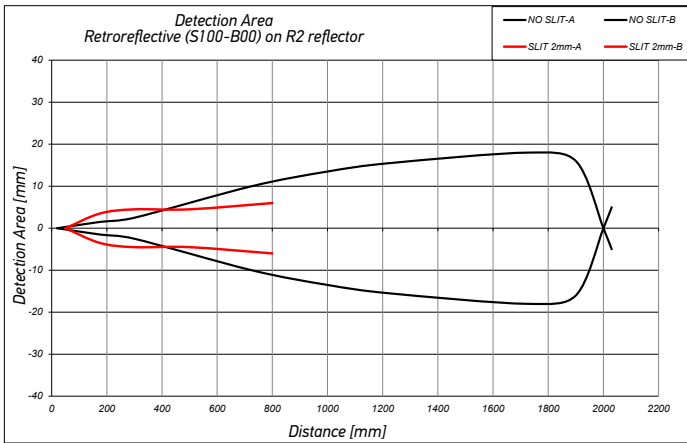

IO-Link POLARIZED RETROREFLECTIVE (LONG RANGE: S100-PR-5-B10-PK, ...-OZ)

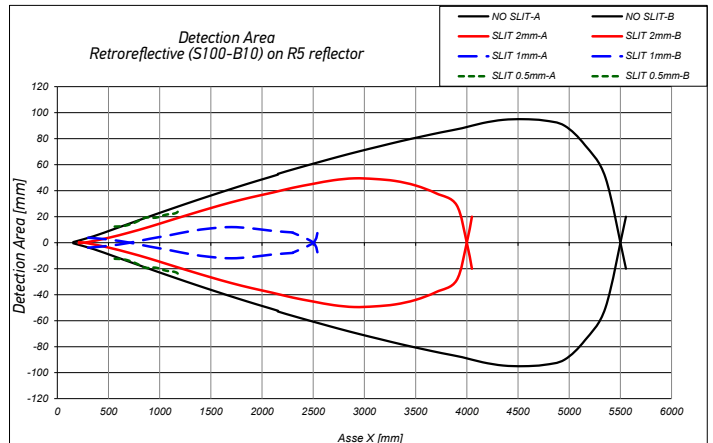
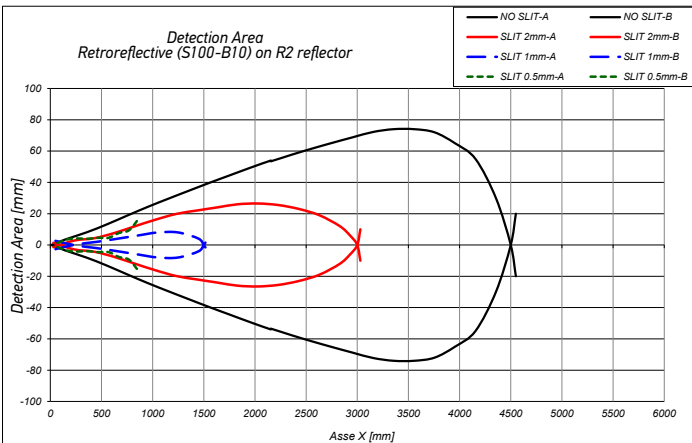

RETROREFLECTIVE (INFRARED)

REFLECTOR	TYPE	(S100-...-A00)
R1	circular (23 mm)	0.03..3 m
R2	circular (48 mm)	0.01..6 m
R3	rectangular (18x54 mm)	0.01..3.5 m
R4	rectangular (47x47 mm)	0.01..5 m
R5	circular (75 mm)	0.01..7 m
R6	rectangular (36x55 mm)	0.01..6 m
RT3970	self-adhesive tape (60x40 mm)	0,05..2 m



	max. operating distance	
	with R5 reflector	with R2 reflector
NO SLIT	7 m	6 m
2 mm SLIT	4,7 m	3,4 m
1 mm SLIT	2,7 m	2,3 m
0,5 mm SLIT	1,5 m	1 m

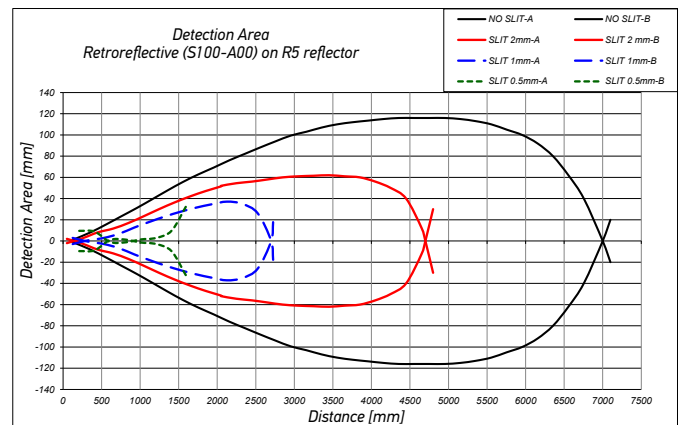
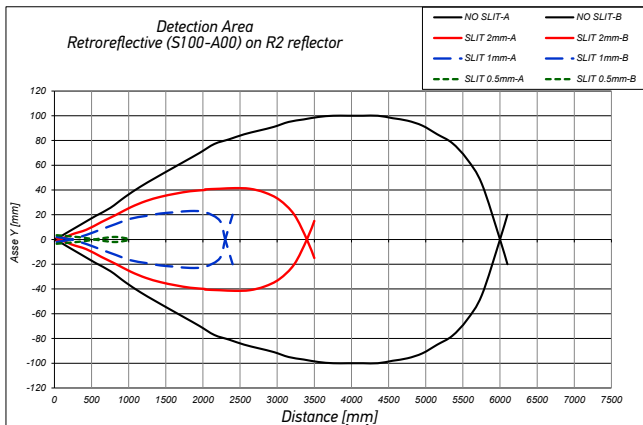

FIXED FOCUS

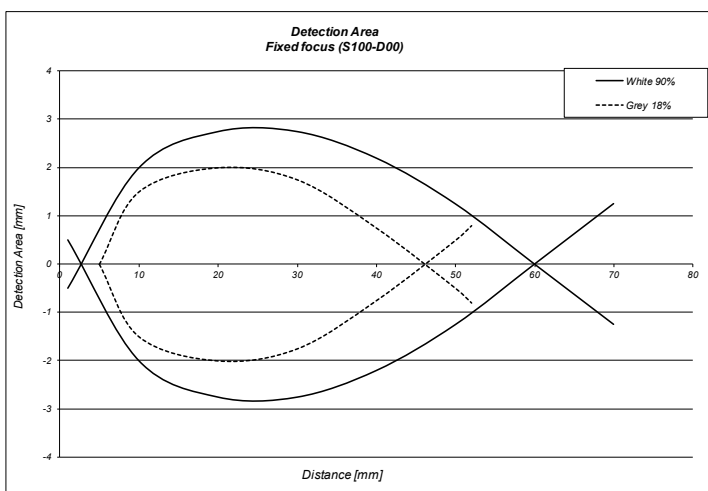

Focus point	70 mm
Maximum operating distance (White 90%)	70 mm
Maximum operating distance (Grey 18%)	55 mm
Difference White/Black	25%

RETROREFLECTIVE FOR TRANSPARENT (INFRARED)

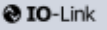
REFLECTOR	TYPE	SHORT RANGE (S100-...-T00)	LONG RANGE (S100-...-T10)	LONG RANGE (S100-...-T10) 
R1	circular (23 mm)	0.1...0.3 m	0.4...1 m	0.1...1 m
R2	circular (48 mm)	0.1...0.5 m	0.8...2 m	0.1...2 m
R3	rectangular (18x54 mm)	0.1...0.3 m	0.4...1 m	0.1...1 m
R4	rectangular (47x47 mm)	0.1...0.5 m	0.8...2 m	0.1...2 m
R5	circular (75 mm)	0.1...0.8 m	0.8...2.5 m	0.1...2.5 m
R6	rectangular (36x55 mm)	0.1...0.5 m	0.8...2m	0.1...2m
RT3970	self-adhesive tape (60x40 mm)	0.15...0.3 m	0.1...0.8 m	0.1...0.8 m

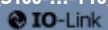

	max. operating distance				
	SHORT RANGE (S100-...-T00)		LONG RANGE (S100-...-T10)		LONG RANGE (S100-...-T10) 
	with R5 reflector	with R2 reflector	with R5 reflector	with R2 reflector	with R2 reflector
NO SLIT	0.1...0.8 m	0.1...0.5 m	0.8...2.5 m	0.8...2 m	0.1...2 m
2 mm SLIT	0.1...0.5 m	0.1...0.3 m	0.5...1.8 m	0.5...1.6 m	0.1...1.6 m
1 mm SLIT	-	-	-	-	-
0,5 mm SLIT	-	-	-	-	-

TRANSPARENT RETROREFLECTIVE (SHORT RANGE: S100-T00)

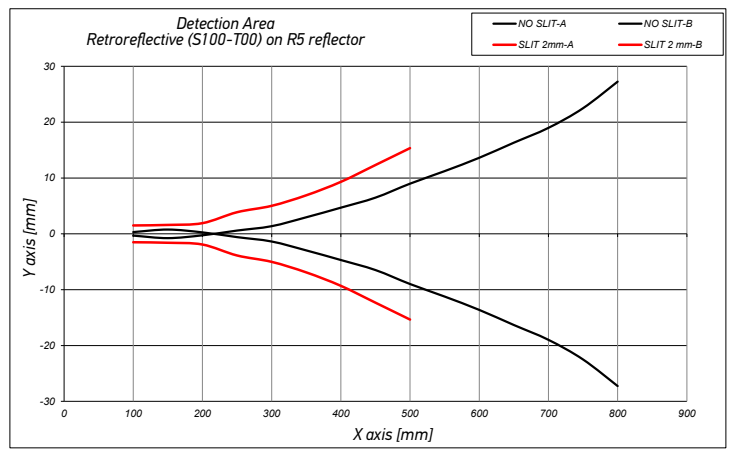
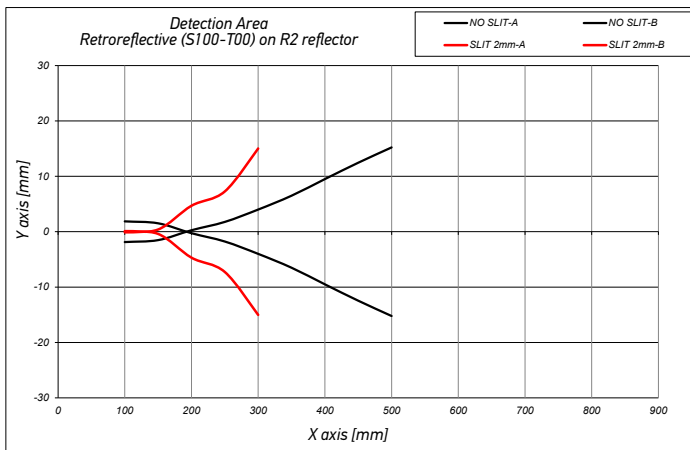

TRANSPARENT RETROREFLECTIVE (LONG RANGE: S100-PR-5-T10-PH, ...OZ)

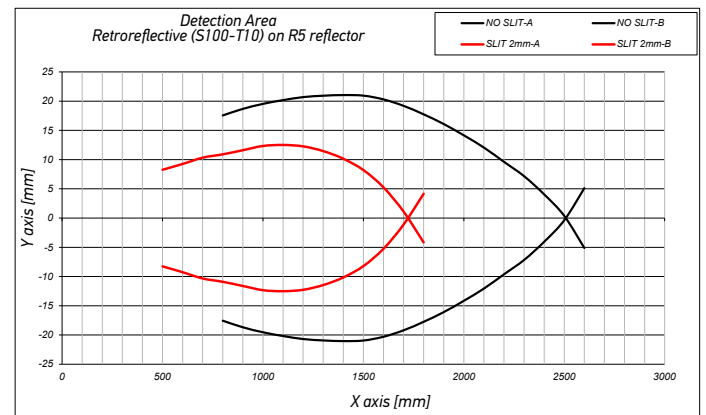
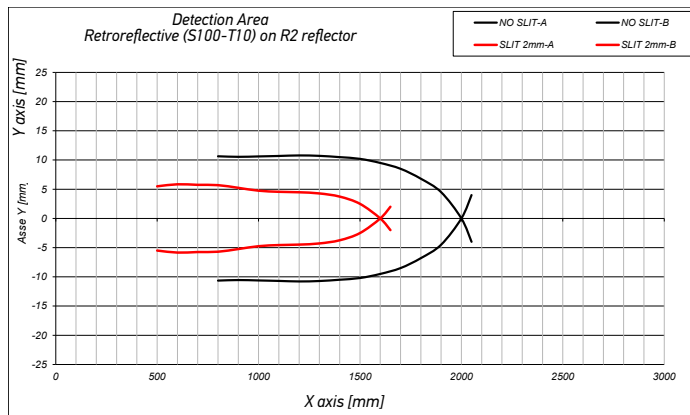

BACKGROUND SUPPRESSION

Operating distances (background suppression)	30...100 mm	30...200 mm	
	S100...M00	S100...M10	S100...M10 
Maximum operating distance (White 90%)	0...150 mm	10...250 mm	10...210 mm
Maximum operating distance (Grey 18%)	10...110 mm	10...135 mm	10...180 mm
Maximum operating distance (Black 6%)	10...80 mm	10...110 mm	10...125 mm
Difference White 90%/White 90%	< 5%	< 10%	< 10%
Difference White 90%/Grey 18%	< 15%	< 32%	< 23%
Difference White 90%/Black 6%	< 25%	< 45%	< 35%

BACKGROUND SUPPRESSION (SHORT RANGE: S100-M00)

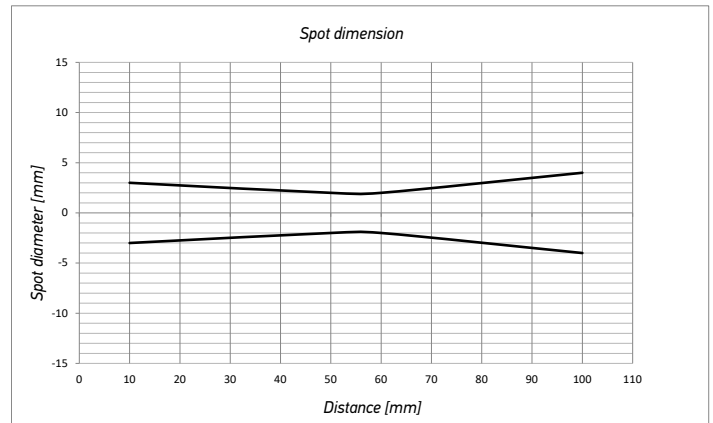
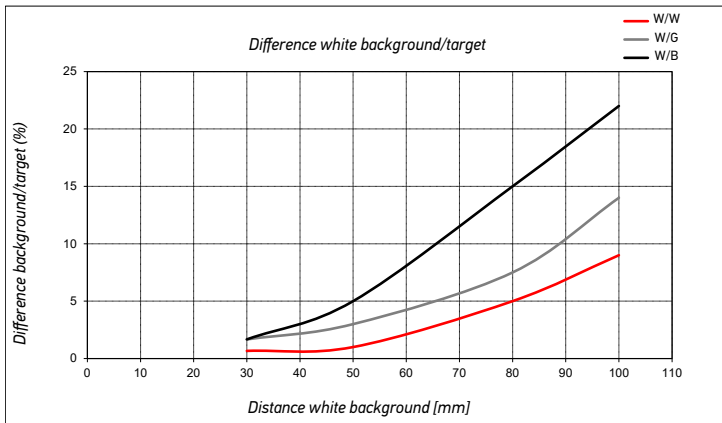

BACKGROUND SUPPRESSION (LONG RANGE: S100-PR-5-M10-PH)

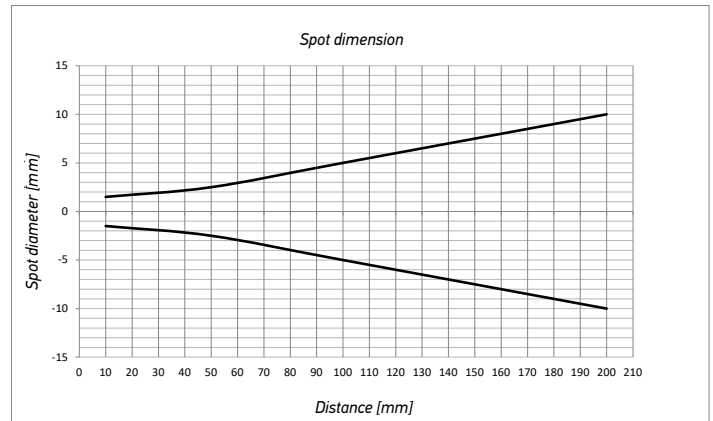
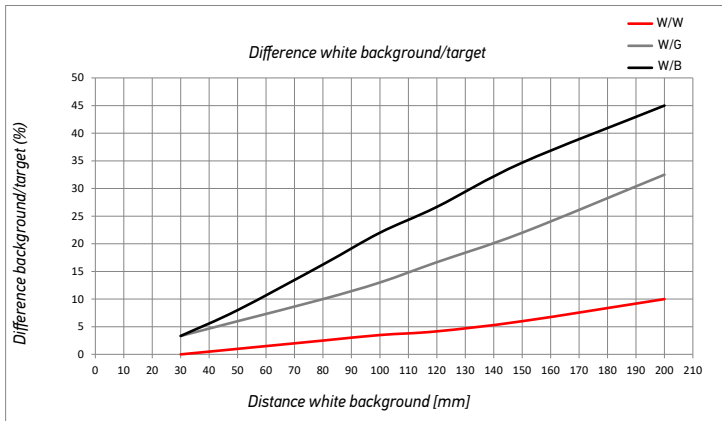

BACKGROUND SUPPRESSION (LONG RANGE: S100-PR-5-M10-OZ)

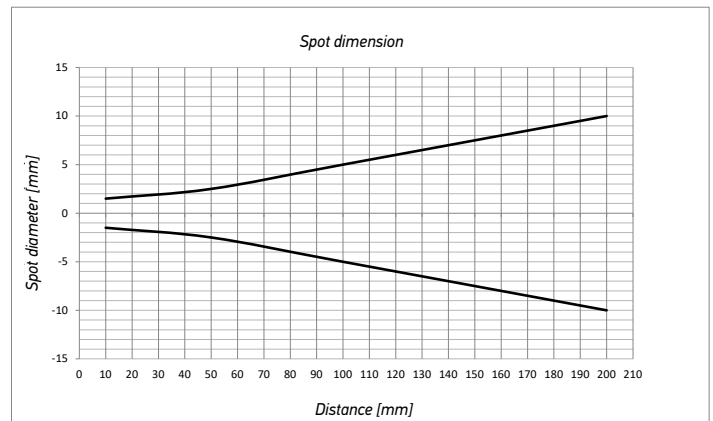
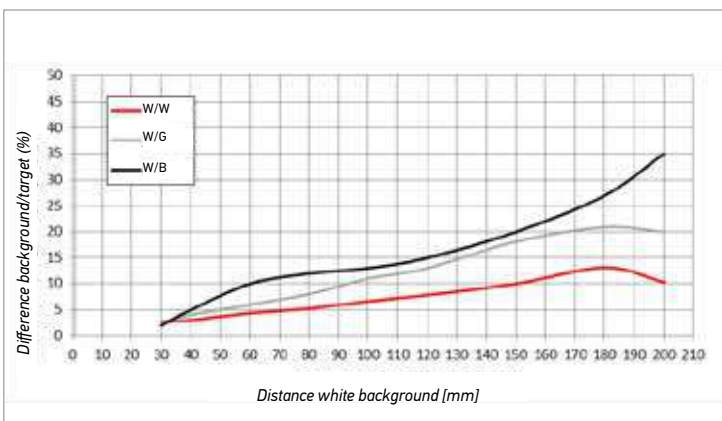

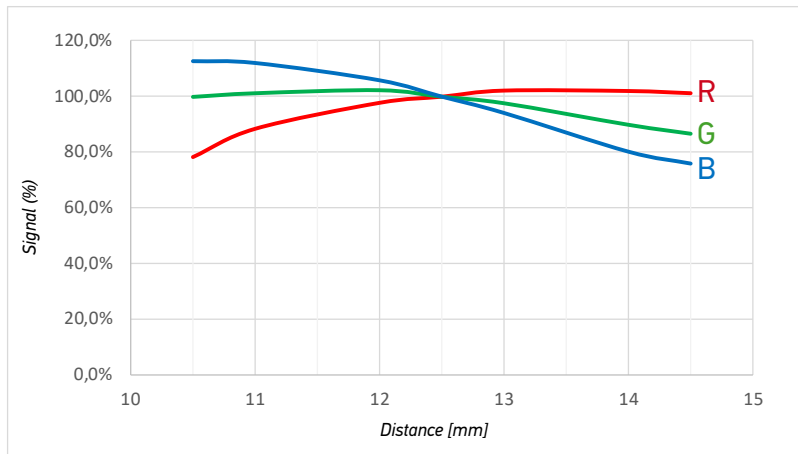

MODEL SELECTION AND ORDER INFORMATION

OPTIC FUNCTION	EMISSION	OPERATING DISTANCE	CONNECTION	OUTPUT	MODEL	ORDER NO.
Through beam	IR	12 m	2 m cable	NPN	S100-PR-2-FG00-NK	950811100
				PNP	S100-PR-2-FG00-PK	950811110
			M8 connector	NPN	S100-PR-5-FG00-NK	950811240
				PNP	S100-PR-5-FG00-PK	950811250
Retroreflective	IR	7 m	2 m cable	NPN	S100-PR-2-A00-NK	950811000
				PNP	S100-PR-2-A00-PK	950811010
			M8 connector	NPN	S100-PR-5-A00-NK	950811140
				PNP	S100-PR-5-A00-PK	950811150
Polarized Retroreflective (short)	RED	2 m	2 m cable	NPN	S100-PR-2-B00-NK	950811020
				PNP	S100-PR-2-B00-PK	950811030
			M8 connector	NPN	S100-PR-5-B00-NK	950811160
				PNP	S100-PR-5-B00-PK	950811170
Polarized Retroreflective (long)	RED	5 m	2 m cable	NPN	S100-PR-2-B10-NK	950811280
				PNP	S100-PR-2-B10-PK	950811290
			M8 connector	NPN	S100-PR-5-B10-NK	950811300
				PNP	S100-PR-5-B10-PK	950811310
				S100-PR-5-B10-OZ	950810001	
Transparent Retroreflective (short)	IR	500 mm	2 m cable	NPN	S100-PR-2-T00-NH	950811330
				PNP	S100-PR-2-T00-PH	950811320
			M8 connector	NPN	S100-PR-5-T00-NH	950811350
				PNP	S100-PR-5-T00-PH	950811340
Transparent Retroreflective (long)	IR	2 m	2 m cable	NPN	S100-PR-2-T10-NH	950811370
				PNP	S100-PR-2-T10-PH	950811360
			M8 connector	NPN	S100-PR-5-T10-NH	950811390
				PNP	S100-PR-5-T10-PH	950811380
				S100-PR-5-T10-OZ	950810002	
Diffuse proximity (short)	RED	300 mm	2 m cable	NPN	S100-PR-2-C00-NK	950811040
				PNP	S100-PR-2-C00-PK	950811050
			M8 connector	NPN	S100-PR-5-C00-NK	950811180
				PNP	S100-PR-5-C00-PK	950811190
Diffuse proximity (long)	RED	500 mm	2 m cable	NPN	S100-PR-2-C10-NK	950811060
				PNP	S100-PR-2-C10-PK	950811070
			M8 connector	NPN	S100-PR-5-C10-NK	950811200
				PNP	S100-PR-5-C10-PK	950811210
Fixed focus	RED	70 mm	2 m cable	NPN	S100-PR-2-D00-NK	950811080
				PNP	S100-PR-2-D00-PK	950811090
			M8 connector	NPN	S100-PR-5-D00-NK	950811220
				PNP	S100-PR-5-D00-PK	950811230
Background suppression (short range)	RED	30...100 mm	2 m cable	NPN	S100-PR-2-M00-NH	950811120
				PNP	S100-PR-2-M00-PH	950811130
			M8 connector	NPN	S100-PR-5-M00-NH	950811260
				PNP	S100-PR-5-M00-PH	950811270
Background suppression (long range)	IR	30...200 mm	2 m cable	NPN	S100-PR-2-M10-NH	950811420
				PNP	S100-PR-2-M10-PH	950811430
			M8 connector	NPN	S100-PR-5-M10-NH	950811400
				PNP	S100-PR-5-M10-PH	950811410
				S100-PR-5-M10-OZ	950810003	
Mark Reader	RGB	12mm +/-2mm	M8 connector	PNP	S100-PR-5-W00-PK	950810005
					S100-PR-5-W00-OZ	950810004

ACCESSORIES

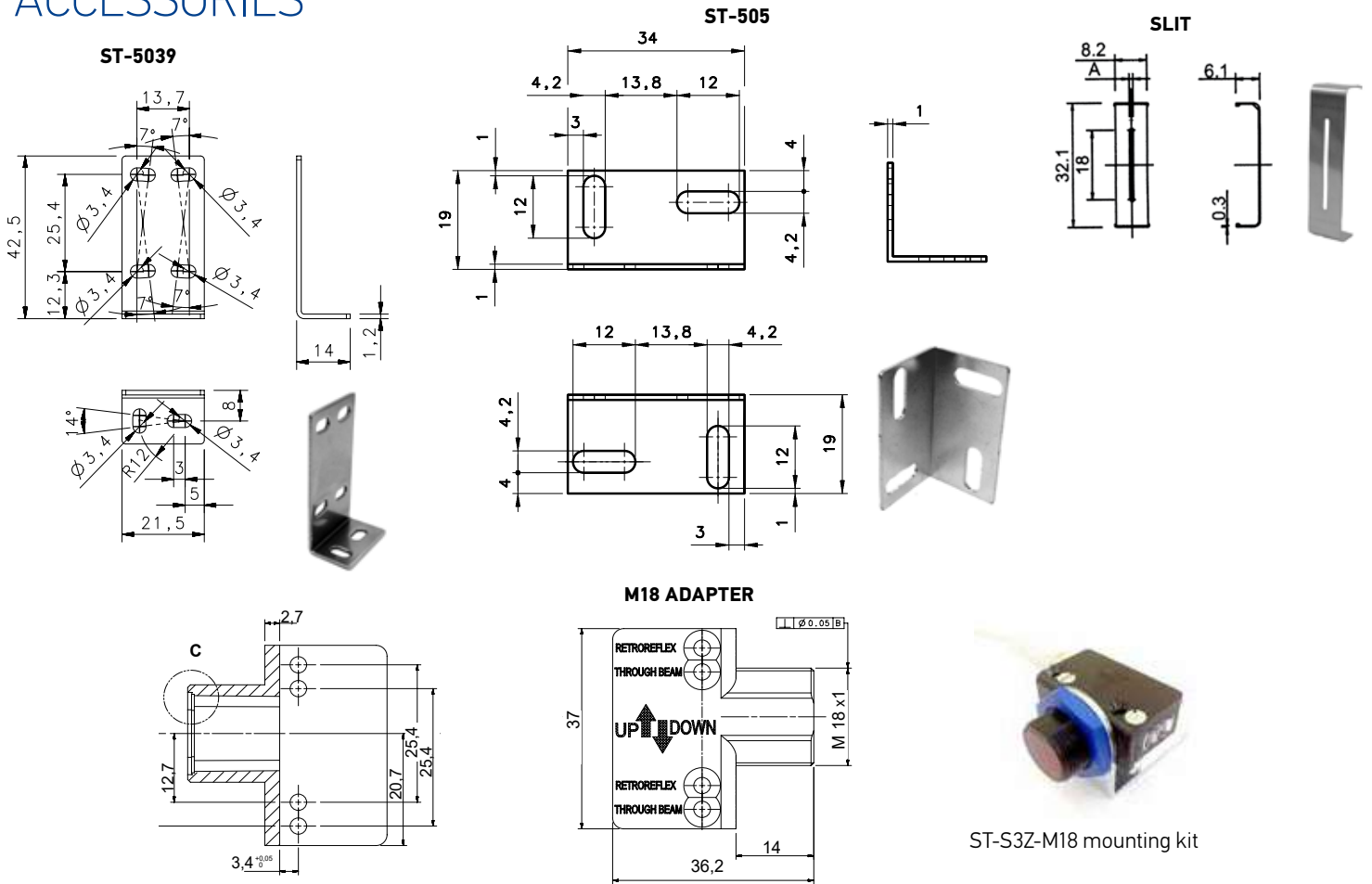

TYPE	MODEL	DESCRIPTION	ORDER NO.
Mounting bracket	ST-505	lateral mounting	95ACC2800
	ST-5039	L-shaped bracket	95ACC2270
Slit	S100-SLIT-05	0,5x19 mm SLIT	95ACC3450
	S100-SLIT-1	1x19 mm SLIT	95ACC3460
	S100-SLIT-2	2x19 mm SLIT	95ACC3470
M18 adapter	ST-S3Z-M18 mounting kit	M18 THREADED ADAPTER NOSE	95ACC7850

IO-LINK CONNECTIVITY		
MODEL	DESCRIPTION	ORDER No.
CBX-8IOL-EIP	CBX-8IOL-EIP 8P IOL M12 EIP MASTER	95ACC8180
CBX-8IOL-PNIO	CBX-8IOL-PNIO 8P IOL M12 PROFINET MASTER	95ACC8190

CABLES				
TYPE	DESCRIPTION	LENGTH	MODEL	ORDER NO.
Axial M8 Connector	4-pole, grey, P.V.C.	3 m	CS-B1-02-G-03	95A251420
		5 m	CS-B1-02-G-05	95A251430
		7 m	CS-B1-02-G-07	95A251440
		10 m	CS-B1-02-G-10	95A251480
Radial M8 Connector	4-pole, P.U.R.	2 m	CS-B1-02-R-02	95A251620
		5 m	CS-B1-02-R-05	95A251640
		10 m	CS-B1-02-R-10	95A251670
Radial M8 Connector	4-pole, grey, P.V.C.	3 m	CS-B2-02-G-03	95A251450
		5 m	CS-B2-02-G-05	95A251460
		7 m	CS-B2-02-G-07	95A251470
		10 m	CS-B2-02-G-10	95A251530
Axial M12 F/M8 M Connector	4-pole, P.U.R.	2 m	CS-B2-02-R-02	95A251630
		5 m	CS-B2-02-R-05	95A251650
Axial M12 F/M8 M Connector	4-pole, double headed	3 m	CS-H1-02-B-03	95ACC0008

Rev. 01, 03/2020

DATALOGIC PRODUCT OFFERING



The company endeavours to continuously improve and renew its products; for this reason the technical data and contents of this catalogue may undergo variations without prior notice. For correct installation and use, the company can guarantee only the data indicated in the instruction manual supplied with the products. Product and Company names and logos referenced may be either trademarks or registered trademarks of their respective companies. We reserve the right to make modifications and improvements.

S100W Instruction Manual



DIMENSIONS

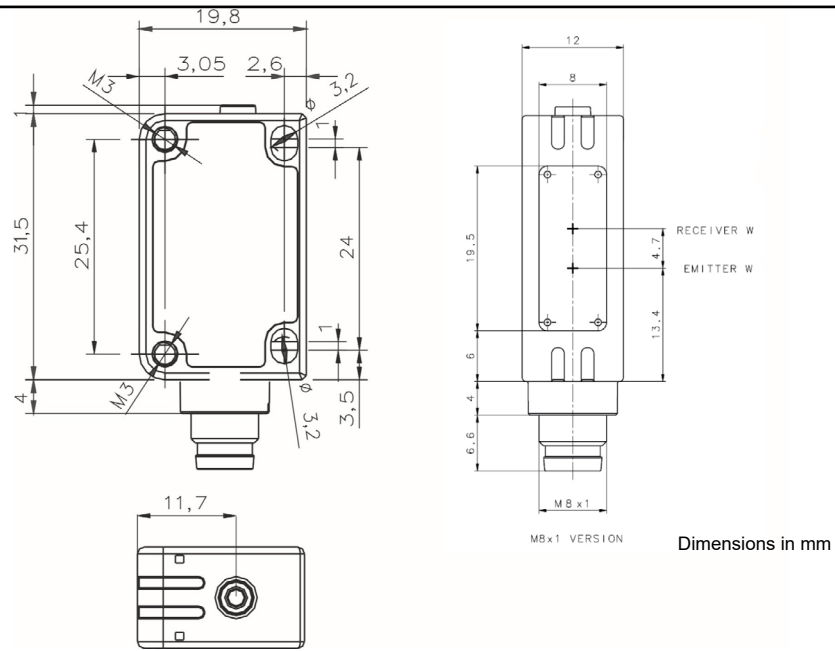

SETTINGS

FINE ACQUISITION

Mark detection
The LIGHT/DARK mode is automatically selected by the sensor. Place the mark in front of the sensor spot and send the IO-Link command. The sensor functions alternating red, green and blue emissions. Do not move the mark during this phase.

Background detection
Place the background in front of the sensor spot and send the IO-Link command. The sensor functions alternating red, green and blue emissions. Do not move the background during this phase.

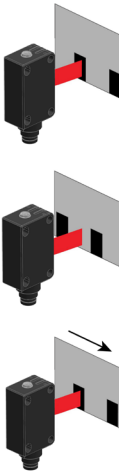

DYNAMIC ACQUISITION

Use dynamic acquisition to acquire moving marks. The sensor detects the contrast between the mark and the moving background, and automatically sets the threshold value. The LIGHT/DARK mode must be set in advance.

If the LED blinks slowly the acquisition failed due to insufficient contrast. Press SET and the sensor returns to the previous setting. Repeat the procedure from the beginning. Check the acquisition status on the process data.

S100W – REMOTE input

The REMOTE signal carries out acquisition functions without using the IO-Link. Configure the N.C. output as a REMOTE input through the IO-Link.

ACQ.

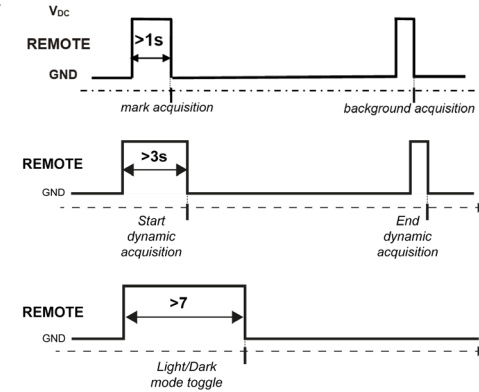

The sensors are NOT safety devices, and so MUST NOT be used in the safety control of the machines where installed.

Datalogic S.r.l.
Via S. Vitalino 13 - 40012 Calderara di Reno - Italy
Tel: +39 051 3147011 - Fax: +39 051 3147205 - www.datalogic.com

Helpful links at www.datalogic.com: **Contact Us, Terms and Conditions, Support.** The warranty period for this product is 36 months. See General Terms and Conditions of Sales for further details.

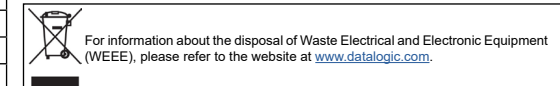

© 2020 Datalogic S.p.A. and/or its affiliates - ALL RIGHTS RESERVED. - Without limiting the rights under copyright, no part of this documentation may be reproduced, stored in or introduced into a retrieval system, or transmitted in any form or by any means, or for any purpose, without the express written permission of Datalogic S.p.A. and/or its affiliates. Datalogic and the Datalogic logo are registered trademarks of Datalogic S.p.A. in many countries, including the U.S.A. and the E.U. All other trademarks and brands are property of their respective owners. Datalogic reserves the right to make modifications and improvements without prior notification.

821006951 Rev. B

CONTROLS

OUTPUT LED – Yellow

The yellow LED indicates the output status.

Please refer to “Settings” for the correct use procedures.

INSTALLATION

The sensor can be positioned by means of the two housing's threaded holes (M3) using two screws (M3x12 or longer or M2.5 passing screw, 0.4 Nm maximum tightening torque) with washers or by mean of the two rear holes using two M3 passing screw, 0.4Nm maximum tightening torque.

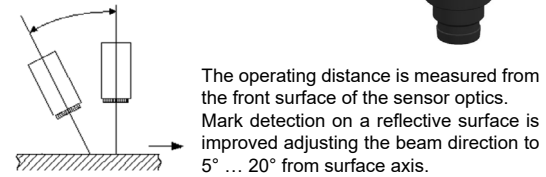

CONNECTIONS

S100W

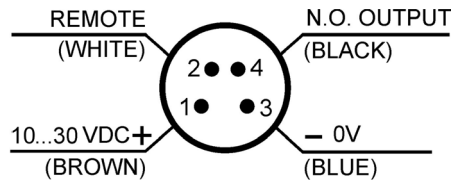

S100W IO-LINK®

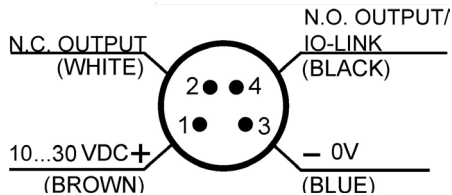

TECHNICAL DATA

Power Supply	10 ... 30 VDC (Class 2 UL508) (reverse polarity protected)
Ripple	10% max.
Current consumption (output current excluded)	35 mA max.
Output / Alarm output	PNP or Push-Pull (short-circuit protection)
Output current	100 mA max.
Output saturation voltage	≤ 2 V
Input	REMOTE (S100W-...-PK)/Pin 2 can be configured as a REMOTE input through IO-Link (S100-...-OZ). The input cannot be kept disconnected.
Response time	25 μs
Switching frequency	20 kHz
Emission type	blue (465 nm) / green (520 nm) / red (630 nm) with automatic selection Exempt Risk Group (RG0) for IEC 62471
Spot dimension	6.5 mm x 1.5 mm
Operating distance (typical values)	12.5 mm
Depth of field	± 2 mm
LIGHT/DARK selection	Automatic
Indicators	Output LED (yellow)
Operating temperature	-25 ... 55 °C
Storage temperature	-40 ... 70 °C
Dielectric strength	1500 VAC 1 min. between electronics and housing
Insulating resistance	>20 MΩ 500 Vdc between electronics and housing
Ambient light rejection	according to EN 60947-5-2
Vibrations	0.5 mm amplitude, 10 ... 55 Hz frequency, for each axis (EN60068-2-6)
Shock resistance	11 ms (30 G) 6 shocks for each axis (EN60068-2-27)
Housing material	Body in ABS; indicators cover in PMMA
Lens material	Frontal window in PMMA; lens in PC
Mechanical protection	IP67
Connections	M8 4-pole connector
Weight	12 g. max



S100W

IO-Link® parameters

PHYSICAL LAYER

Description	
IO-Link Revision	1.1
SIO Modus	YES
Min Cycle Time	2.3 ms
Transmission Rate	38.4 kbit/s (COM2)
Process Data Length	PDInput: 3 Bit PDDOutput: Not used
M-Sequence Capability	PREOPERATE: TYPE_0 OPERATE: TYPE_2_1 ISDU: supported

FEATURES

Description	
Block Parameter	YES
Data Storage	YES
Supported Access Locks	Parameter (write) access Data Storage
Profile Characteristic	Device Profile: Smart Sensor Function Class: Device Identification Function Class: Switching Signal Channel Function Class: Device Diagnosis Function Class: Teach Channel Function Class: Teach-in Single Value

SERVICE DATA

The following ISDUs will not be saved via Data Storage: Device Access Locks (index 0xC), Teach-in Channel (index 0x3A), Emitter Status (index 0x51)

System Parameters							
Index (dec)	Parameter Object Name	Length	Subindex (offset)	Value/Range	Description	Data Type	Access*
0x000C (12)	Device Access Locks	2 octets		Bit 1: Data Storage (0 = unlocked, 1 = locked)	Standardized Device locking functions: Bit 0: Parameter (write) access (Not used) Bit 1: Data Storage Bit 2: Local parameterization (Not used) Bit 3: Local user interface (Not used) Bit 4-15: Reserved	RecordT	R/W
0x000D (13)	Profile Characteristics	2 octets 2 octets 2 octets 2 octets 2 octets 2 octets		0x0001 0x8000 0x8001 0x8003 0x8004 0x8007	Smart Sensor Profile Device Identification Switching Signal Channel (SSC) Device Diagnosis Teach Channel Teach-in single value	ArrayT of UIntegerT16	RO
0x000E (14)	PDInput Descriptor	3 octets 3 octets 3 octets		0x01.0x01.0x00 0x01.0x01.0x01 0x01.0x01.0x02	SSC1 (OUT0) SSC2 (OUT1) TEACH STATUS FLAG	ArrayT of OctetStringT3	RO

*RO = read only, WO = write only, R/W = read/write

Identification Parameters								
Index (dec)	Parameter Object Name	Length	Subindex (offset)	Value/Range	Description	Data Type	Access*	Remark
0x0010 (16)	Vendor Name	9 octets		DATALOGIC	Informative	StringT	RO	
0x0011 (17)	Vendor Text	19 octets		Empower your vision		StringT	RO	
0x0012 (18)	Product Name	16 octets		See "Device variant collection"	Detailed product name	StringT	RO	
0x0013 (19)	Product ID	5 octets		See "Device variant collection"	Product identification	StringT	RO	
0x0014 (20)	Product Text	22 octets		See "Device variant collection"		StringT	RO	
0x0015 (21)	Serial Number	9 octets			Unique serial number	StringT	RO	
0x0016 (22)	Hardware Revision	5 octets		RevAE		StringT	RO	
0x0017 (23)	Firmware Revision	5 octets		1.0.1		StringT	RO	
0x0018 (24)	Application Specific Tag	32 octets		*** (default)	Tag application defined by user	StringT	R/W	Saved in non-volatile memory
0x0019 (25)	Function Tag	32 octets		*** (default)	Additional tag for device function identification	StringT	R/W	Saved in non-volatile memory
0x001A (26)	Location Tag	32 octets		*** (default)	Additional tag for device function identification	StringT	R/W	Saved in non-volatile memory

Observation / Diagnostic Parameters								
Index (dec)	Parameter Object Name	Length	Subindex (offset)	Value/Range	Description	Data Type	Access*	Remark
0x0028 (40)	Process Data Input	1 octet			Read last valid Process Data Input from PDin channel	Device specific	RO	
0x0041 (65)	Analog Signal	2 octets			Read analog signal	UIntegerT	RO	
0x0052 (82)	Device Temperature	2 octets 2 octets 2 octets 2 octets 2 octets	1(64) 2(48) 3(32) 4(16) 5(0)		Device temperature actual Device min. temperature since powerup Device max. temperature since powerup Device min. temperature during lifetime Device max. temperature during lifetime	IntegerT IntegerT IntegerT IntegerT IntegerT	RO RO RO RO RO	
0x0053 (83)	Device Temperature Threshold	2 octets 2 octets	1(16) 2(0)		Device min. temperature threshold Device max. temperature threshold	IntegerT IntegerT	R/W	Saved in non-volatile memory every hour. Events are generated if the device temperature exceeds the thresholds.
0x0057 (87)	Operating Hours	4 octets 4 octets 4 octets	1(64) 2(32) 3(0)	0...(2^32)-1	Operating Hours: device operating hours. Not resettable by user. Operating Hours Maintenance: device operating hours, reset on system command "Confirm Maintenance". Operating Hours Power Up: Time in hours since power up.	UIntegerT UIntegerT UIntegerT	RO RO RO	
0x0024 (36)	Device Status	1 octet		0x00 → Device is operating properly 0x01 → Maintenance Required 0x02 → Out of specification 0x03 → Functional Check 0x04 → Failure	Contains current status of the device	UIntegerT	RO	
0x0025 (37)	Detailed Device Status	3 octets			Information about currently pending Events. Implemented as dynamic list.	UIntegerT	RO	
0x0051 (81)	Emitter Status	1 octet		0x00 = Emitter OFF 0x01 = Emitter ON	Contains current status of the emitter	BooleanT	RO	
0x0059 (89)	RGB selection	1 octet		0x01 = Red emission 0x02 = Green emission 0x03 = Blue emission	Select emission type	UIntegerT	R/W	Saved in non-volatile memory

*RO = read only, WO = write only, R/W = read/write

Teach-in Parameters								
Index (dec)	Parameter Object Name	Length	Subindex (offset)	Value/Range	Description	Data Type	Access*	Remark
0x003A (58)	TI Select	1 octet		0x00 = SSC1 (default, C/Q pin and DO pin)	Selection for Teach-in channel (volatile)	UIntegerT	R/W	C/Q and DO outputs are antivalent. Teach SSC1 equals to teach SSC2
0x003B (59)	TI Result	1 octet	1(0) 2(4) 3(5)	Teach-in State Flag SP1 TP1 Flag SP2 TP1	See IO-Link Smart Sensor Profile	UIntegerT4 BooleanT BooleanT	RO	
0x003C (60)	SSC1 Param	2 octets 2 octets	1(16) 2(0)	280-1950 Not used	Switching threshold	UIntegerT	R/W	Saved in non-volatile memory
0x003D (61)	SSC1 Config	1 octet	1(24)	0x00: High Active 0x01: Low Active (default)	C/Q pin configuration	UIntegerT	R/W	Saved in non-volatile memory
		1 octet	2(16)	0x01: Single Point (default)		UIntegerT		
		2 octets	3(0)	0 ..2 Hysteresis		UIntegerT		
0x003E (62)	SSC2 Param	2 octets 2 octets	1(16) 2(0)	280-1950 Non used	Switching threshold	UIntegerT	R/W	Saved in non-volatile memory
0x003F (63)	SSC2 Config	1 octet	1(24)	0x00: High Active (default) 0x01: Low Active	DO pin configuration	UIntegerT	R/W	Saved in non-volatile memory
		1 octet	2(16)	0x01: Single Point (default)		UIntegerT		
		2 octets	3(0)	0 ..2 Hysteresis		UIntegerT		
0x0040 (64)	Sensitivity selection	1 octet		0 ..10 Sensitivity	Sensitivity	UIntegerT	R/W	Saved in non-volatile memory

Device Specific Parameters								
Index (dec)	Parameter Object Name	Length	Subindex (offset)	Value/Range	Description	Data Type	Access*	Remark
0x0048 (72)	Delay Settings	1 octet	1(8)	0 = no delay (default) 0x4 = Delay OFF	Select Delay mode (OFF)	UIntegerT	R/W	Saved in non-volatile memory. Max. Value 255 ms *Available for future Beta samples
		1 octet	2(0)	0...(2^8)-1	Delay value = Delay [ms]	UIntegerT	R/W	
0x00B4 (180)	Output type	1 octet	1(8)	0x01 = PNP (default) 0x03 = Push Pull ⁽¹⁾	Output type of C/Q pin when in SIO mode	UIntegerT	R/W	Saved in non-volatile memory
		1 octet	2(0)	0x01 = PNP (default) 0x03 = Push Pull 0x04 = Input	Output type of DO pin	UIntegerT	R/W	

⁽¹⁾ The No Output configured in Push Pull mode with an NPN load does not reactivate after a short circuit condition. Remove the short circuit condition and cycle power to the sensor.

Standard Command					
Index (dec)	Command Name	Lenght	Value (dec)	Description	Access*
0x0002 (2)	SP1 Teach TP1	1 octet	0x43 (67)	Acquisition FINE: Mark Detection (refer to User's Manual)	WO
0x0002 (2)	SP1 Teach TP2	1 octet	0x44 (68)	Acquisition FINE: Background Detection (refer to User's Manual)	WO
0x0002 (2)	Teach Dynamic	1 octet	0x4B (75)	Dynamic acquisition	WO
0x0002 (2)	Teach Dynamic End	1 octet	0x4F (79)	Exit from Dynamic Detection	WO
0x0002 (2)	Restore Factory Settings	1 octet	0x82 (130)	Restore factory settings: Device Access Locks, Application Specific Tag, Function Tag, Location Tag, SSC1 Param, SSC2 Param, Delay Settings, Output Type, RGB Selection, Device Temperature Thresholds, Emission Color, Sensitivity	WO
0x0002 (2)	Confirm Maintenance	1 octet	0xA5 (165)	Reset Maintenance parameters (Operating Hours Maintenance, Minimum device temperature since powerup, Maximum device temperature since powerup, Device Status, Detailed Device Status)	WO
0x0002 (2)	Disable/enable emission	1 octet	0xB0 (176)	Toggle emission (enable / disable emission)	WO
0x0002 (2)	Start / Stop Ping	1 octet	0xAF (175)	Feature to identify the sensor by yellow LED blinking	WO

Events					
Event code (dec)	Event name	Event mode	Event type	Device status	Remarks
0x4220 (16928)	Temperature underrun	Appears / Disappears	Warning	Out of specification	
0x4210 (16912)	Temperature overrun	Appears / Disappears	Warning	Out of specification	
0x5100 (20736)	General power supply fault	Appears / Disappears	Error	Failure	
0x7710 (30480)	Short circuit - Check installation	Appears / Disappears	Error	Failure	

PROCESS DATA

Process Data Input							
Byte 0							
7	6	5	4	3	2	1	0
Not used					TEACH-IN	SSC2 (DO pin)	SSC1 (C/Q pin)

DEVICE VARIANT COLLECTION

Product name	Product ID	Product text
S100-PR-5-W00-OZ	10004	Contrast sensor

⁽²⁾ Process data will not be valid in case of out-of-range values.