



## **Raccordi a calzamento in ottone**

Brass quick fittings

Schnellverschraubungen Messing

Raccords à coiffe laiton

Racordaje rápido en latón

**RC50KG**



**RC50G**



**RC51OR**



**RC51ORM**



**RC51K**



**RC51**



**RC51M**



**RC52**



**RC53**



**RC54**



**RC55K**



**RC55M**



**RC55KG**



**RC55OR**



**RC55F**



**RC56**



**RC57OR**



**RC57K**



**RC58K**



**RC59**



**RC60**



**RC61**



**RC62**



**RC65**



**RC66**



**RC72**



## **Dati tecnici dei raccordi a calzamento in ottone**

Brass quick fittings technical data

Technischen Daten der Schnellverschraubungen Messing

Données techniques des raccords à coiffe laiton

Datos técnicos de los racordaje rápido en latón

### **Caratteristiche principali**

1. Tenuta garantita su differenti tipologie di tubi
2. Filettatura BSPP cilindrica UNI-ISO228 con O-Ring, BSPT conica UNI-ISO 7, Metrica ISO/R 262
3. Guarnizione in NBR Silicon free
4. Robustezza meccanica
5. Tenuta garantita su differenti tipologie di tubi
6. Vasta gamma

### **Principales caractéristiques**

1. Raccordement sécurisé
2. Filetage BSPP cylindrique UNI-ISO228, BSPT conique UNI-ISO 7, ISO/R 262 métrique
3. Garniture NBR sans silicone
4. Grande résistance mécanique
5. Raccordement sécurisé
6. Large gamme

### **Main features**

1. Safely connection
2. Threading BSPP cylindrical UNI-ISO228 with O-Ring, BSPT taper UNI-ISO 7, ISO/R 262 metric
3. Silicon free NBR seal
4. Mechanical resistance
5. Safely connection
6. Wide range

### **Características principales**

1. Estanqueidad garantizada con diferentes tipos de tubo
2. Roscado BSPP cilíndrica UNI-ISO228 con junta tórica, BSPT cónica UNI-ISO 7, métrica ISO/R 262,
3. Guarnición en NBR sin silicona
4. Robustez mecánica
5. Estanqueidad garantizada con diferentes tipos de tubo
6. Amplia gama

### **Hauptmerkmale**

1. Sichere Verbindung
2. BSPP zylindrisches Gewinde UNI-ISO228 mit O-Ring, BSPT konische UNI-ISO 7, metrische ISO/R 262
3. Silikonfreie NBR-Dichtung
4. Mechanische Festigkeit
5. Sichere Verbindung
6. Große Auswahl

## Applicazioni

1. Aria compressa
2. Impianti per automazione pneumatica
3. Gas inerti, vapore, fluidi
4. Circuiti acqua industriale
5. Vuoto

## Applications

1. Air comprimé
2. Installations pour l'automatisation pneumatique
3. Gaz neutres, vapeur
4. Circuits d'eau industrielle
5. Vide

## Applications

1. Compressed Air
2. Systems for pneumatic automation
3. Inert Gases, Fluids, Steam
4. Industrial water circuits
5. Vacuum

## Aplicaciones

1. Aire comprimido
2. Instalaciones para automación neumática
3. Gases inertes, vapor, fluidos
4. Circuitos de agua industrial
5. Vacío

## Anwendungen

1. Druckluft
2. Systeme für die pneumatische Automatisierung
3. Inertgase, Flüssigkeiten, Dampf
4. Industrielle Wasserkreisläufe
5. Leer

Materiali	Materials	Werkstoffen	Matériels	Materiales
<b>Corpo:</b> Ottone nichelato CW614N	<b>Body:</b> Nickel plated brass CW614N	<b>Körper:</b> vernickelt Messing CW614N	<b>Corps:</b> Laiton nickelé CW614N	<b>Cuerpo:</b> Latón niquelado CW614N
<b>Dado:</b> Ottone nichelato CW614N	<b>Nut:</b> Nickel plated brass CW614N	<b>Mutter:</b> vernickelt Messing CW614N	<b>Écrou:</b> Laiton nickelé CW614N	<b>Tuerca:</b> Latón niquelado CW614N
<b>O-Ring:</b> NBR esente da silicone	<b>O-Ring:</b> NBR silicon free	<b>O-Ringe:</b> NBR Silikonfrei	<b>O-ring:</b> NBS sans silicone	<b>Junta tórica:</b> NBR sin silicona

**Dado**  
Nut  
Mutter  
Écrou  
Tuerca

**Corpo**  
Body  
Körper  
Corps  
Cuerpo

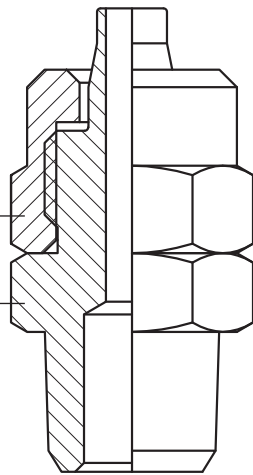

**Corpo**  
Body  
Körper  
Corps  
Cuerpo

**O-Ring**  
O-Ring  
O-Ringe  
O-Ring  
Juntas tóricas

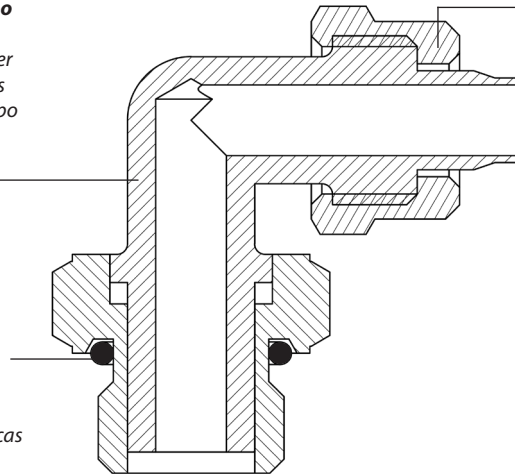

**Dado**  
Nut  
Mutter  
Écrou  
Tuerca

## Temperature e pressioni

Le temperature e le pressioni dipendono dalle caratteristiche del tubo impiegato (Pressione consigliata: 18 Bar)

## Pressure and temperature

Temperatures and pressures depend on the characteristics of the pipe used (Recommended pressure: 18 Bar)

## Temperatur und druck

Temperaturen und Drücke hängen von den Eigenschaften der verwendeten Leitung ab (empfohlener Druck: 18 Bar)

## Températures et pressions

Les températures et les pressions dépendent des caractéristiques du tuyau utilisé (pression recommandée: 18 bar)

## Temperaturas y presiones

Las temperaturas y las presiones dependen de las características de la tubería utilizada (Presión recomendada: 18 bar)

## Fluido

Aria compressa, acqua (altri fluidi a richiesta)

## Fluid

Compressed air, water (other fluids on request)

## Fluid

Druckluft, Wasser (andere Medien auf Anfrage)

## Fluide

Air comprimé, eau (autres fluides sur demande)

## Fluido

Aire comprimido, agua (otros fluidos a petición)

## Tubi consigliati

1)Poliuretano - 2)Poliammide - 3)Polietilene - 4)Nylon

## Recommended tubes

1)Polyurethane - 2)Polyamide - 3)Polyethylene - 4)Nylon

## Rohrempfehlungen

1)Polyurethan - 2)Polyamid - 3)Polyethylen - 4)Nylon

## Tuyaux recommandés

1)Polyuréthane 2) Polyamide 3) Polyéthylène 4) Nylon

## Tubos recomendados

1) Poliuretano - 2) Poliàmida - 3) Polietileno - 4) Nylon

## Diametri e filetti

Diametri da 4mm a 15mm - Filettature da M5 a 1/2"

## Threads and diameters

Diameters from 4mm to 15mm - Threads from M5 to 1/2"

## Durchmesser und Gewinde



Durchmesser von 4mm bis 15mm - Gewinde von M5 bis 1/2"





## Diamètres et filets

Diamètres de 4mm à 15mm - Filetages de M5 à 1/2"





## Diámetros y roscas

Diámetros de 4mm a 15mm - Roscas de M5 a 1/2"

 Filettatura	 Thread types	 Gewinde	 Filetage	 Roscado
BSPP cilindrica UNI-ISO228 - ISO16030 con O-Ring	BSPP parallel UNI-ISO228 - ISO16030 with O-ring	BSPP zylindrisch UNI-ISO228 - ISO16030 mit O-Ringen	BSPP cylindrique UNI-ISO228 - ISO 16030 avec O-ring	BSPP cilíndrico UNI-ISO 228 - ISO 16030 con junta tórica
BSPT conica UNI-ISO 7	BSPT taper UNI-ISO 7	BSPT konische UNI-ISO 7	BSPT conique UNI-ISO7	Recubrimiento BSPT UNI-ISO 7
Metrica ISO/R 262	Metric ISO/R 262	Metrische ISO/R 262	Métrique ISO/R 262	ISO/R 262 métrica



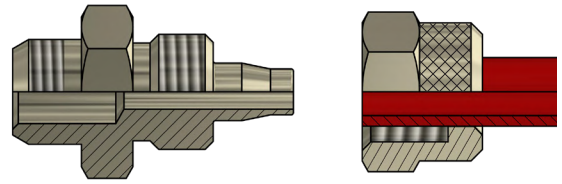

-  **Montaggio**
-  **Assembling**
-  **Montageanleitung**
-  **Assemblage**
-  **Montaje**

**1**

-  **Inserire il tubo nel dado**
-  Insert the tube on the nut
-  Schieben sie das Rohr durch die Überwurfmutter
-  Insérer le tube à travers l'écrou
-  Insertar el tubo en la tuerca





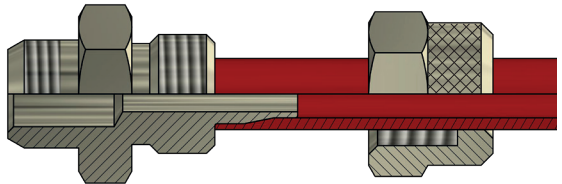

**2**



-  **Infilare il tubo sul cono di calzamento**
-  Thread the tube on the fitting cone
-  Stecken sie das Rohr auf den Konus der Verschraubung
-  Insérer le tube sur la canule
-  Introducir el tubo en el cono del racor



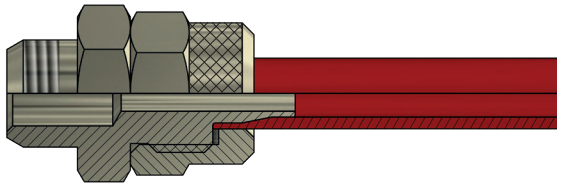

**3**

-  **Avvitare il dado di bloccaggio a mano o con una chiave**
-  Tighten the nut by hand or with a spanner
-  Ziehen sie die Überwurf-mutter von Hand oder mit einem Schlüssel an
-  Assembler et sérer l'écrou à la main ou avec une clé
-  Atornillar la tuerca de bloqueo a mano o con una llave



-  **Norma di riferimento**
-  **Norme de référence**

-  **Reference standard**
-  **Normativa de referencia**

 **Entspricht der Norm**



## RC 50KG

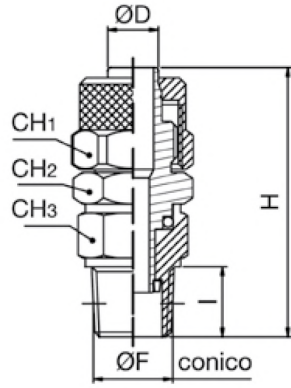

**Diritto girevole maschio conico BSPT**

Male straight rotating body taper BSPT

Gerade Einschraubverschraubung konisches Gewinde

Raccord orientable mâle BSPT conique

Racor orientable macho cónico BSPT

CODICE/CODE	ØD	F"	I	H	CH1	CH2	CH3	PEZZI/PIECES
<b>RC50KG1806</b>	6/4	R1/8	8	37	12	12	12	10
<b>RC50KG1406</b>	6/4	R1/4	11	40	12	14	14	10
<b>RC50KG1808</b>	8/6	R1/8	8	37	14	12	12	10
<b>RC50KG1408</b>	8/6	R1/4	11	40	14	14	14	10
<b>RC50KG1410</b>	10/8	R1/4	11	42	16	14	14	10
<b>RC50KG3812</b>	12/10	R3/8	11,5	44	18	17	17	10

## RC 50G

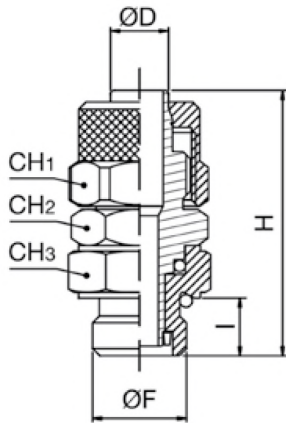

**Diritto girevole maschio cilindrico con O-ring BSPP**

Male straight rotating body parallel BSPP with O-ring

Gerade Einschraubverschraubung zylindrisches Gewinde mit O-Ring

Raccord orientable mâle, cylindrique BSPP avec O-ring

Racor orientable macho cilíndrico con tórica BSPP con O-ring

CODICE/CODE	ØD	F"	I	H	CH1	CH2	CH3	PEZZI/PIECES
<b>RC50G1806</b>	6/4	G1/8	6	36	12	12	13	10
<b>RC50G1406</b>	6/4	G1/4	8	37,5	12	14	16	10
<b>RC50G1808</b>	8/6	G1/8	6	36	14	12	13	10
<b>RC50G1408</b>	8/6	G1/4	8	37,5	14	14	16	10
<b>RC50G1410</b>	10/8	G1/4	8	39	16	14	16	10
<b>RC50G380812</b>	12/8	G3/8	9	42	18	17	19	10
<b>RC50G3812</b>	12/10	G3/8	9	42	18	17	19	10

## RC 51OR

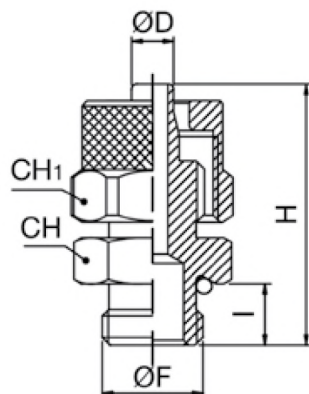

**Diritto maschio cilindrico con O-ring BSPP**

Male straight parallel BSPP with O-ring

Gerade Einschraubverschraubung zylindrisches Gewinde mit O-Ring

Raccord mâle, cylindrique BSPP avec O-ring

Racor macho cilíndrico con tórica BSPP con O-ring

CODICE/CODE	ØD	F"	I	H	CH	CH1	PEZZI/PIECES
<b>RC51OR1804</b>	4/2.7	G1/8	6	21,8	13	8	10
<b>RC51OR1805</b>	5/3	G1/8	6	23	13	8	10
<b>RC51OR1806</b>	6/4	G1/8	6	25,5	13	12	10
<b>RC51OR1406</b>	6/4	G1/4	8	28	16	12	10
<b>RC51OR3806</b>	6/4	G3/8	9	29	19	12	10
<b>RC51OR1206</b>	6/4	G1/2	10	30,5	24	12	10
<b>RC51OR1808</b>	8/6	G1/8	6	26	14	14	10
<b>RC51OR1408</b>	8/6	G1/4	8	28	16	14	10
<b>RC51OR3808</b>	8/6	G3/8	9	29	19	14	10
<b>RC51OR1208</b>	8/6	G1/2	10	30,5	24	14	10
<b>RC51OR1810</b>	10/8	G1/8	6	28	14	16	10
<b>RC51OR1410</b>	10/8	G1/4	8	29,5	16	16	10
<b>RC51OR3810</b>	10/8	G3/8	9	30,5	19	16	10
<b>RC51OR1210</b>	10/8	G1/2	10	32	24	16	10
<b>RC51OR3812</b>	12/10	G3/8	9	32	19	18	10
<b>RC51OR1212</b>	12/10	G1/2	10	33,5	24	18	10
<b>RC51OR1215</b>	15/12.5	G1/2	10	35,5	24	22	10

## RC 51ORM

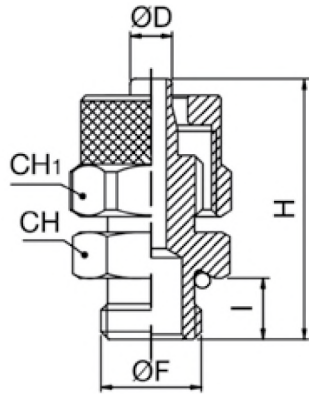

**Dritto maschio cilindrico con O-ring metrico**

Male straight metric with O-ring

Gerade Einschraubverschraubung metrisches Gewinde mit O-Ring

Raccord droit mâle, cylindrique, métrique

Racor recto macho cilíndrico con tórica, métrico

CODICE/CODE	ØD	F"	I	H	CH	CH1	PEZZI/PIECES
RC51ORM542	4/2,7	M5	4	20	8	8	10
RC51ORM642	4/2,7	M6	4	20	8	8	10
RC51ORM505	5/3	M5	4	20,5	8	8	10
RC51ORM605	5/3	M6	4	20,5	8	8	10
RC51ORM506	6/4	M5	4	21	8	12	10
RC51ORM606	6/4	M6	4	21	8	12	10
RC51ORM12106	6/4	M12x1	8	28	15	12	10
RC51ORM12126	6/4	M12x1,25	8	28	15	12	10
RC51ORM12156	6/4	M12x1,5	8	28	15	12	10
RC51ORM12128	8/6	M12x1,25	8	28	17	14	10
RC51ORM12158	8/6	M12x1,5	8	28	17	14	10

## RC 51K

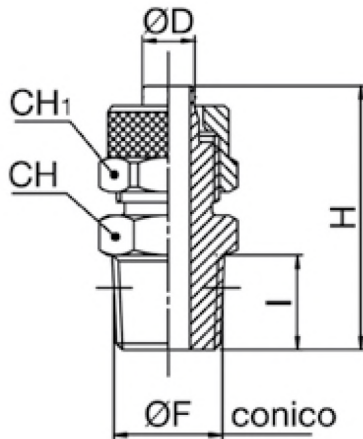

**Dritto maschio conico BSPT**

Male straight taper BSPT

Gerade Einschraubverschraubung konisches Gewinde

Raccord droit male BSPT conique

Racor recto macho cónico BSPT

CODICE/CODE	ØD	F"	I	H	CH	CH1	PEZZI/PIECES
RC51K1804	4/2.7	R1/8	8	23,8	12	8	10
RC51K1805	5/3	R1/8	8	25	10	9	10
RC51K1806	6/4	R1/8	8	27	12	12	10
RC51K1406	6/4	R1/4	11	31	14	12	10
RC51K3806	6/4	R3/8	10,5	31	17	12	10
RC51K1808	8/6	R1/8	8	27	12	14	10
RC51K1408	8/6	R1/4	10,5	31	14	14	10
RC51K3808	8/6	R3/8	10,5	31	17	14	10
RC51K1208	8/6	R1/2	14	34,5	22	14	10
RC51K1810	10/8	R1/8	8	28	14	16	10
RC51K1410	10/8	R1/4	10,5	32	14	16	10
RC51K3810	10/8	R3/8	10,5	32	17	16	10
RC51K1210	10/8	R1/2	14	36	22	16	10
RC51K3812	12/10	R3/8	11,5	34,5	17	18	10
RC51K1212	12/10	R1/2	14	37,5	22	18	10
RC51K1215	15/12.5	R1/2	14	39,5	22	22	10

## RC 51

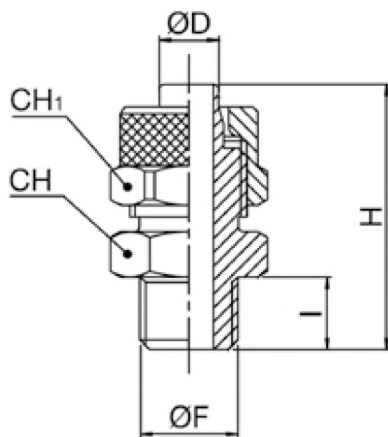

**Dritto maschio cilindrico BSPP**

Male straight parallel BSPP

Gerade Einschraubverschraubung zylindrisches Gewinde

Raccord droit mâle, cylindrique BSPP





Racor recto macho cilíndrico BSPP

CODICE/CODE	ØD	F"	I	H	CH	CH1	PEZZI/PIECES
RC511805	5/3	G1/8	6	23	14	8	10
RC511806	6/4	G1/8	6,5	26	14	12	10
RC511406	6/4	G1/4	9	29	16	12	10
RC513806	6/4	G3/8	9	29	19	12	10
RC511808	8/6	G1/8	6,5	26	14	14	10
RC511408	8/6	G1/4	9	29	16	14	10
RC513808	8/6	G3/8	9	29	19	14	10
RC511810	10/8	G1/8	6,5	26	14	16	10
RC511410	10/8	G1/4	9	31	16	16	10
RC513810	10/8	G3/8	9	31	19	16	10
RC511210	10/8	G1/2	10	32	24	16	10
RC513812	12/10	G3/8	9	32	19	18	10
RC511212	12/10	G1/2	10	33,5	24	18	10
RC511215	15/12.5	G1/2	10	33,5	24	22	10

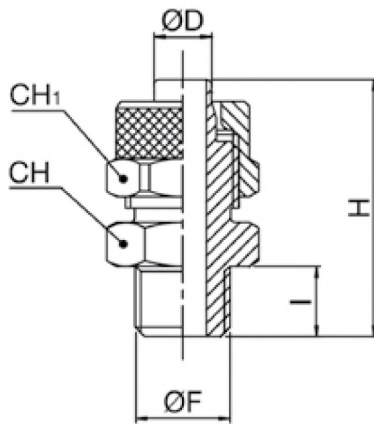

## RC 51M





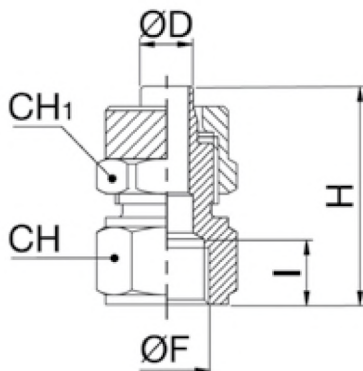

-  **Diritto maschio cilindrico metrico**
-  Male straight parallel metric
-  Gerade Einschraubverschraubung metrisches Gewinde
-  Raccord droit mâle, cylindrique métrique
-  Racor recto macho cilíndrico con tórica métrico

CODICE/CODE	ØD	F"	I	H	CH	CH1	PEZZI/PIECES
<b>RC51M505</b>	5/3	M5	4	20	8	8	10
<b>RC51M605</b>	5/3	M6	5	21	8	8	10
<b>RC51M506</b>	6/4	M5	4	21	9	8	10
<b>RC51M606</b>	6/4	M6	5	22	9	8	10
<b>RC51M12256</b>	6/4	M12X1.25	8	28	17	12	10
<b>RC51M12506</b>	6/4	M12X1.50	8	28	17	12	10
<b>RC51M12258</b>	8/6	M12X1.25	8	28	17	14	10
<b>RC51M12508</b>	8/6	M12X1.50	8	28	17	14	10

## RC 52





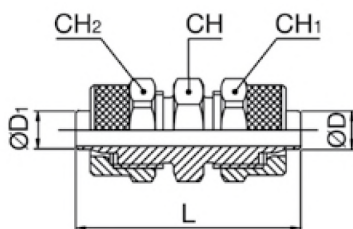

-  **Femmina diritto cilindrico BSPP**
-  Female straight parallel BSPP
-  Gerade Einschraubverschraubung
-  Raccord droit, taraude cylindrique BSPP
-  Racor recto hembra cilíndrico BSPP

CODICE/CODE	ØD	F"	I	H	CH	CH1	PEZZI/PIECES
<b>RC521804</b>	4/2.7	G1/8	8	21,3	14	8	10
<b>RC521805</b>	5/3	G1/8	8	22,5	14	8	10
<b>RC521806</b>	6/4	G1/8	9	26	14	12	10
<b>RC521406</b>	6/4	G1/4	11	29	17	12	10
<b>RC523806</b>	6/4	G3/8	11,5	29,5	20	12	10
<b>RC521808</b>	8/6	G1/8	9	26	14	14	10
<b>RC521408</b>	8/6	G1/4	10	28	16	14	10
<b>RC523808</b>	8/6	G3/8	11,5	29,5	20	14	10
<b>RC521208</b>	8/6	G1/2	14	33	14	24	10
<b>RC521810</b>	10/8	G1/8	8	26,5	14	16	10
<b>RC521410</b>	10/8	G1/4	10	30	16	16	10
<b>RC523810</b>	10/8	G3/8	11,5	31	20	16	10
<b>RC521210</b>	10/8	G1/2	14	34,5	24	16	10
<b>RC523812</b>	12/10	G3/8	11,5	32,5	20	18	10

## RC 53





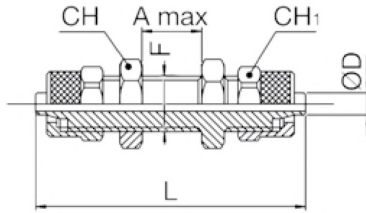

-  **Diritto intermedio**
-  Straight intermediate
-  Gerader Verbinder
-  Raccord union double
-  Racor recto intermedio

CODICE/CODE	ØD	ØD1	L	CH	CH1	CH2	PEZZI/PIECES
<b>RC530004</b>	4/2.7	4/2.7	26	8	8	8	10
<b>RC530005</b>	5/3	5/3	28,5	8	8	8	10
<b>RC530006</b>	6/4	6/4	34,5	12	12	12	10
<b>RC530806</b>	8/6	6/4	35,5	14	14	12	10
<b>RC530008</b>	8/6	8/6	35	14	14	14	10
<b>RC530010</b>	10/8	10/8	38	14	16	16	10
<b>RC530012</b>	12/10	12/10	41	17	18	18	10
<b>RC530015</b>	15/12.5	15/12.5	45,5	22	22	22	10

## RC 54





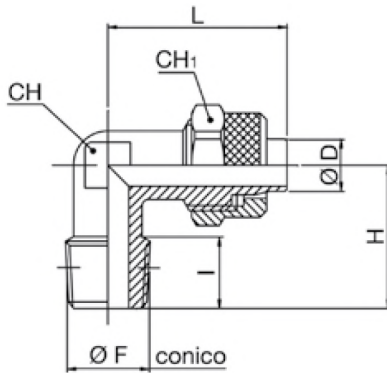

-  **Passalamiera**
-  **Union bulkhead**
-  **Schottverschraubung**
-  **Raccord traversée de cloison**
-  **Racor recto intermedio pasatabiques**

CODICE/CODE	ØD	F"	L	A max	CH	CH1	PEZZI/PIECES
<b>RC540004</b>	4/2.7	M8x1	36,7	8,5	9	8	10
<b>RC540005</b>	5/3	M8x1	40	8,5	9	8	10
<b>RC540006</b>	6/4	M10x1	48	10,5	14	12	10
<b>RC540008</b>	8/6	M12x1	48	10,5	16	14	10
<b>RC540010</b>	10/8	M14x1	50	8,5	17	16	10
<b>RC540012</b>	12/10	M16x1	53	8,5	19	18	10
<b>RC540015</b>	15/12.5	M20x1	58	8,5	24	22	10

## RC 55K





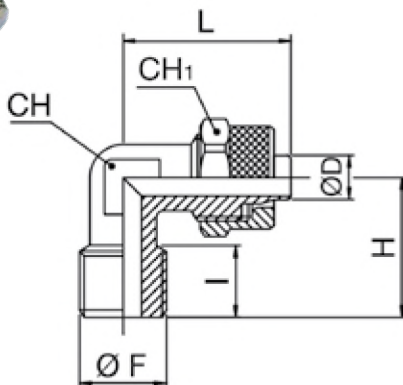
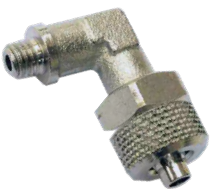

-  **Gomito maschio conico BSPT**
-  **Elbow male taper BSPT**
-  **Winkelverschraubung drehbar konisches Gewinde**
-  **Equerre mâle conique BSPT**
-  **Racor a L macho cónico BSPT**

CODICE/CODE	ØD	F"	I	H	L	CH	CH1	PEZZI/PIECES
<b>RC55K1804</b>	4/2.7	R1/8	8	17	19,5	8	8	10
<b>RC55K1805</b>	5/3	R1/8	8	17	21,5	8	8	10
<b>RC55K1806</b>	6/4	R1/8	8	17	22,5	8	12	10
<b>RC55K1406</b>	6/4	R1/4	11	20	22,5	10	12	10
<b>RC55K3806</b>	6/4	R3/8	11,5	22,5	23,5	11	12	10
<b>RC55K1808</b>	8/6	R1/8	8	17	22,5	10	14	10
<b>RC55K1408</b>	8/6	R1/4	11	20	22,5	10	14	10
<b>RC55K3808</b>	8/6	R3/8	11,5	22,5	24	11	14	10
<b>RC55K1208</b>	8/6	R1/2	14	28	26,5	17	14	10
<b>RC55K1810</b>	10/8	R1/8	8	18,5	25,5	11	16	10
<b>RC55K1410</b>	10/8	R1/4	11	21,5	25,5	11	16	10
<b>RC55K3810</b>	10/8	R3/8	11,5	22,5	25,5	11	16	10
<b>RC55K1210</b>	10/8	R1/2	14	28	28	17	16	10
<b>RC55K1412</b>	12/10	R1/4	11	24	30	14	18	10
<b>RC55K3812</b>	12/10	R3/8	11,5	24,5	30	14	18	10
<b>RC55K1212</b>	12/10	R1/2	14	28	30,5	17	18	10
<b>RC55K1215</b>	15/12.5	R1/2	14	28	34	17	22	10

## RC 55M



-  **Gomito maschio cilindrico metrico**
-  **Metric elbow male**
-  **Winkelverschraubung drehbar metrisches Gewinde**
-  **Equerre orientable mâle, métrique**
-  **Racor a L orientable macho métrico**

CODICE/CODE	ØD	F"	I	H	L	CH	CH1	PEZZI/PIECES
<b>RC55M504</b>	4/2,7	M5	4	15	19,5	8	8	10
<b>RC55M604</b>	4/2,7	M6	5	13	20	9	9	10
<b>RC55M505</b>	5/3	M5	4	15	21,5	8	8	10
<b>RC55M506</b>	6/4	M5	4	15	22,5	9	8	10
<b>RC55M12256</b>	6/4	M12X1.25	9	20,5	22,5	12	10	10
<b>RC55M12506</b>	6/4	M12X1.50	9	20,5	22,5	12	10	10
<b>RC55M12258</b>	8/6	M12X1.25	9	20,5	22,5	14	10	10
<b>RC55M12508</b>	8/6	M12X1.50	9	20,5	22,5	14	10	10

## RC 55KG

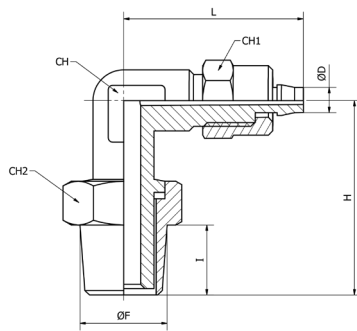

**Gomito maschio girevole conico BSPT**

Elbow male (with rotating body) taper BSPT

Winkelverschraubung drehbar konisches Gewinde

Equerre orientable mâle, conique BSPT

Racor a L orientable macho cónico BSPT

CODICE/CODE	ØD	F"	I	H	L	CH	CH1	CH2	PEZZI/PIECES
<b>RC55KG1804</b>	4/2	R1/8	8	23	20,5	8	8	12	10
<b>RC55KG1806</b>	6/4	R1/8	8	22	22	8	12	12	10
<b>RC55KG1406</b>	6/4	R1/4	11	26	23	10	12	16	10
<b>RC55KG1808</b>	8/6	R1/8	8	22	23	10	14	12	10
<b>RC55KG1408</b>	8/6	R1/4	11	26	23	10	14	16	10
<b>RC55KG1410</b>	10/8	R1/4	11	27	25,5	11	16	16	10

## RC 55OR

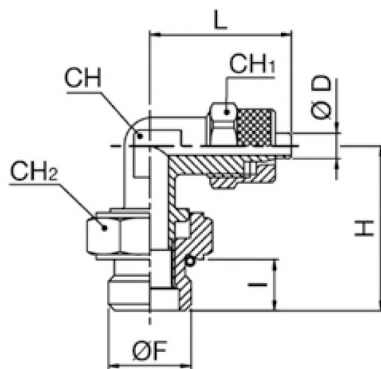

**Gomito maschio girevole cilindrico con O-ring BSPP**

Elbow male (rotating body) with O-ring parallel BSPP

Winkelverschraubung drehbar mit O-Ring

Equerre orientable mâle, cylindrique BSPP avec O-ring

Racor a L orientable macho cilíndrico con tórica BSPP con O-ring

CODICE/CODE	ØD	F"	I	H	L	CH	CH1	CH2	PEZZI/PIECES
<b>RC55OR1804</b>	4/2.7	G1/8	6	22,5	21,5	8	12	14	10
<b>RC55OR1806</b>	6/4	G1/8	6	22,5	22,5	8	12	14	10
<b>RC55OR1406</b>	6/4	G1/4	8	25	23,5	10	12	17	10
<b>RC55OR1808</b>	8/6	G1/8	6	22,5	23,5	10	14	14	10
<b>RC55OR1408</b>	8/6	G1/4	8	25	23,5	10	14	17	10
<b>RC55OR1410</b>	10/8	G1/4	8	25,5	23,5	11	16	17	10

## RC 55F

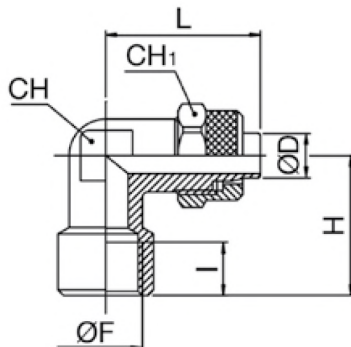

**Gomito femmina cilindrico BSPP**

Elbow female parallel BSPP

Winkelverschraubung drehbar

Equerre femelle cylindrique BSPP

Racor a L hembra cilíndrico BSPP

CODICE/CODE	ØD	F"	I	H	L	CH	CH1	PEZZI/PIECES
<b>RC55F1805</b>	5/3	G1/8	8	19	21,5	8	10	10
<b>RC55F1806</b>	6/4	G1/8	8	19	22,7	12	10	10
<b>RC55F1406</b>	6/4	G1/4	11	23	24,5	12	11	10
<b>RC55F1808</b>	8/6	G1/8	8	19	22,7	14	10	10
<b>RC55F1408</b>	8/6	G1/4	11	23	25	14	11	10
<b>RC55F1410</b>	10/8	G1/4	11	23,5	26	16	11	10
<b>RC55F3812</b>	12/10	G3/8	11,5	28	30,5	18	17	10

## RC 56

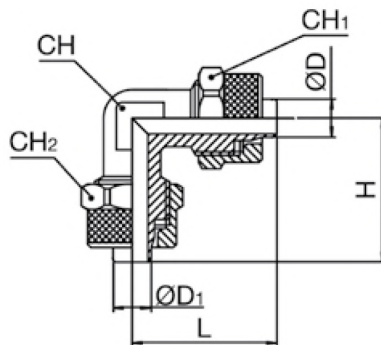

**L intermedio**

L intermédiaire

Winkelverbinder

Raccord equerre





Racor a L intermedio

CODICE/CODE	ØD	ØD1	H	L	CH	CH1	CH2	PEZZI/PIECES
<b>RC560004</b>	4/2.7	4/27	20	20	9	9	9	10
<b>RC560005</b>	5/3	5/3	21,5	21,5	8	8	8	10
<b>RC560006</b>	6/4	6/4	21,5	21,5	8	12	12	10
<b>RC560008</b>	8/6	8/6	22,5	22,5	10	14	14	10
<b>RC560010</b>	10/8	10/8	25,5	25,5	11	16	16	10
<b>RC560012</b>	12/10	12/10	30	30	14	18	18	10
<b>RC560015</b>	15/12,5	15/12,5	34	34	17	22	22	10
<b>RC560806</b>	8/6	6/4	22,5	22,5	10	14	12	10

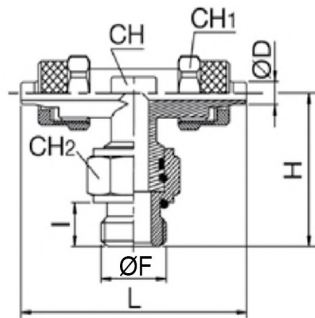

## RC 57OR





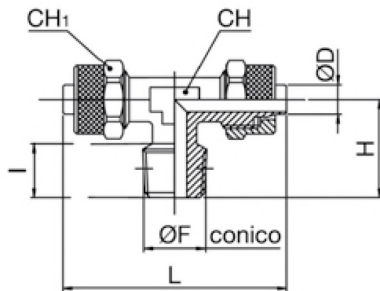

-  **T girevole centrale maschio cilindrico BSPP con O-ring**
-  Central T male (rotating body) parallel BSPP with O-ring
-  T-Mehrfachverteiler mit O-Ring
-  Té orientable à piquage mâle central, cylindrique avec O-ring
-  Racor a T orientable macho central cilíndrico con tórica con O-ring

CODICE/CODE	ØD	ØF	I	H	L	CH	CH1	CH2	PEZZI/PIECES
<b>RC57OR1804</b>	4/2.7	G1/8	6	25,7	45	8	8	13	10
<b>RC57OR1806</b>	6/4	G1/8	6	25,7	45	8	12	13	10
<b>RC57OR1406</b>	6/4	G1/4	8	29	45,5	10	12	17	10
<b>RC57OR1808</b>	8/6	G1/8	6	26	45,5	10	14	13	10
<b>RC57OR1408</b>	8/6	G1/4	8	28	45,5	10	14	17	10
<b>RC57OR1410</b>	10/8	G1/4	8	29	51	11	16	17	10

## RC 57K





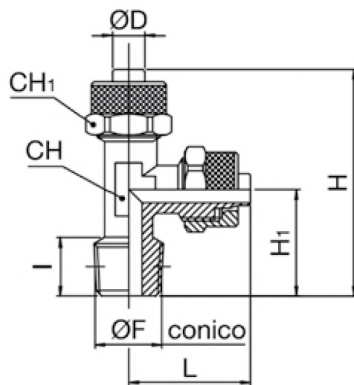

-  **T al centro conico BSPT-metrico**
-  Central T taper BSPT-metric
-  T-Schwenkverschraubung drehbar konisches-metrisches Gewinde
-  Té à piquage mâle central, conique, métrique
-  Racor a T macho central cónico, métrico

CODICE/CODE	ØD	F"	I	L	H	CH1	CH	PEZZI/PIECES
<b>RC57K1804</b>	4/2.7	R1/8	8	40,6	17	8	8	10
<b>RC57M505</b>	5/3	M5	4	43	15	8	8	10
<b>RC57K1805</b>	5/3	R1/8	8	43	17	8	8	10
<b>RC57K1806</b>	6/4	R1/8	8	45	17	12	8	10
<b>RC57K1406</b>	6/4	R1/4	10,5	45,5	20,5	12	10	10
<b>RC57K3806</b>	6/4	R3/8	11,5	48	22,5	12	11	10
<b>RC57K1808</b>	8/6	R1/8	8	45,5	17,5	14	10	10
<b>RC57K1408</b>	8/6	R1/4	11	45,5	20,5	14	10	10
<b>RC57K3808</b>	8/6	R3/8	11,5	48	22,5	14	11	10
<b>RC57K1810</b>	10/8	R1/8	8	51	18,5	16	12	10
<b>RC57K1410</b>	10/8	R1/4	10,5	51	21,5	16	12	10
<b>RC57K3810</b>	10/8	R3/8	11,5	51	22,5	16	11	10
<b>RC57K1210</b>	10/8	R1/2	14	57	28	17	16	10
<b>RC57K3812</b>	12/10	R3/8	11,5	60	24,5	18	14	10
<b>RC57K1212</b>	12/10	R1/2	14	61	28	18	17	10
<b>RC57K1215</b>	15/12.5	R1/2	14	68	28	22	17	10

## RC 58K



-  **T laterale conico BSPT-metrico**
-  Lateral T male taper BSPT-metric
-  T-Verschraubung drehbar konisches-metrisches Gewinde
-  Té à piquage mâle latérale, conique BSPT, métrique
-  Racor a T macho lateral cónico BSPT, métrico

CODICE/CODE	ØD	F"	I	H	L	H1	CH1	CH	PEZZI/PIECES
<b>RC58K1804</b>	4/2,7	R1/8	8	38	21,5	17	8	8	10
<b>RC58M504</b>	4/2	M5	4	36,5	21,5	15	8	8	10
<b>RC58K1805</b>	5/3	R1/8	8	38,5	21,5	17	8	8	10
<b>RC58K1806</b>	6/4	R1/8	8	39,5	22,5	17	12	8	10
<b>RC58K1406</b>	6/4	R1/4	10,5	43,5	22,7	20,7	12	10	10
<b>RC58K3806</b>	6/4	R3/8	11,5	46,5	24	22,5	12	11	10
<b>RC58K1808</b>	8/6	R1/8	8	40,5	22,7	17,7	14	10	10
<b>RC58K1408</b>	8/6	R1/4	10,5	43,5	22,7	20,7	14	10	10
<b>RC58K3808</b>	8/6	R3/8	11,5	46,5	24	22,5	14	11	10
<b>RC58K1810</b>	10/8	R1/8	8	44	25,5	18,5	16	11	10
<b>RC58K1410</b>	10/8	R1/4	10,5	46,5	25,5	21	16	12	10
<b>RC58K3810</b>	10/8	R3/8	11,5	48	25,5	22,5	16	11	10
<b>RC58K1210</b>	10/8	R1/2	14	56,5	28,5	28	16	17	10
<b>RC58K3812</b>	12/10	R3/8	11,5	54,5	30	24,5	18	14	10
<b>RC58K1212</b>	12/10	R1/2	14	58,5	30,5	28	18	17	10
<b>RC58K1215</b>	15/12.5	R1/2	14	62	34	28	22	17	10

## RC 59

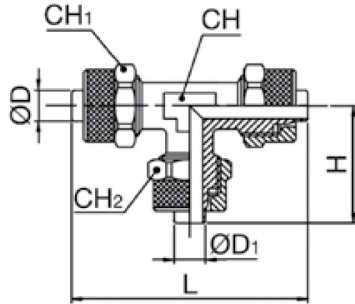

-  **T intermedio**
-  T intermediate
-  T-Verbinder
-  Raccord T
-  Racor a T intermedio

CODICE/CODE	ØD	ØD1	H	L	CH	CH1	CH2	PEZZI/PIECES
<b>RC590004</b>	4/2.7	4/2.7	20,3	40,6	8	8	8	10
<b>RC590005</b>	5/3	5/3	21,5	43	8	8	8	10
<b>RC590006</b>	6/4	6/4	22,5	45	8	12	12	10
<b>RC590008</b>	8/6	8/6	22,5	45	10	14	14	10
<b>RC590010</b>	10/8	10/8	25,5	51	11	16	16	10
<b>RC590012</b>	12/10	12/10	30	60	14	18	18	10
<b>RC590015</b>	15/12.5	15/12.5	34	68	17	22	22	10
<b>RC590806</b>	8/6	6/4	22,5	45	10	14	12	10

## RC 60

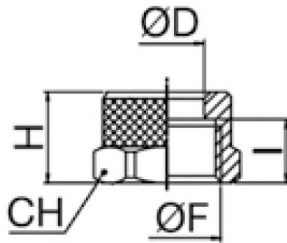



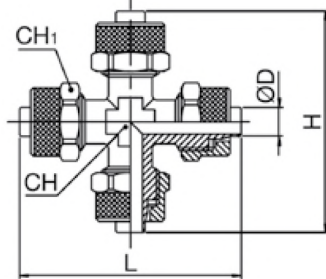

-  **Dado**
-  Nut
-  Verbindungsmutter
-  Ecrou
-  Tuerca

CODICE/CODE	ØD	F"	I	H	CH	PEZZI/PIECES
<b>RC600004</b>	4/2,7	M6x0,5	6	8,1	8	10
<b>RC600005</b>	5/3	M7x0,75	6	8,5	8	10
<b>RC600806</b>	6/4	M8x0,75	6,5	9	9	10
<b>RC601006</b>	6/4	M10x1	7,5	10,5	12	10
<b>RC600008</b>	8/6	M12x1	7,5	10,5	14	10
<b>RC600010</b>	10/8	M14x1	8,5	11,5	16	10
<b>RC600012</b>	12/10	M16x1	10	13	18	10
<b>RC600015</b>	15/12,5	M20x1	11	15,5	22	10

## RC 61



-  **Croce intermedio**
-  Cross intermediate
-  Kreuzverteiler
-  Croix égale
-  Racor a cruz intermedio

CODICE/CODE	ØD	H	L	CH	CH1	PEZZI/PIECES
<b>RC610006</b>	6/4	45	45	8	12	10
<b>RC610008</b>	8/6	45	45	10	14	10
<b>RC610010</b>	10/8	51	51	11	16	10

## RC 62

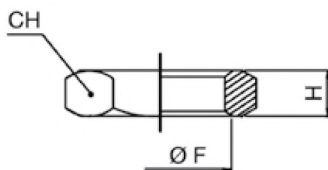

-  **Ghiera**
-  Nut
-  Mutter
-  Écrou
-  Tuerca

CODICE/CODE	F"	H	CH	PEZZI/PIECES
<b>RC6200M5</b>	M5	2,5	9	10
<b>RC620018</b>	G1/8	4,5	14	10
<b>RC620014</b>	G1/4	5	17	10
<b>RC620038</b>	G3/8	5,5	19	10
<b>RC620012</b>	G1/2	6	24	10
<b>RC620034</b>	G3/4	5	30	10
<b>RC620001</b>	G1"	6	38	10

## RC 65

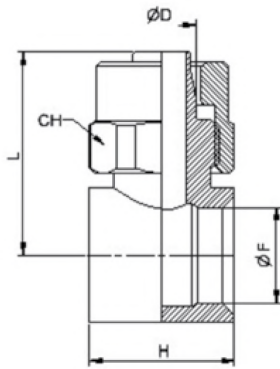

### 🇮🇹 Banjo singolo

- 🇬🇧 Banjo (single)
- 🇩🇪 Ringstück einfach
- 🇫🇷 Raccord banjo
- 🇪🇸 Racor banjo

CODICE/CODE	ØD	F"	H	L	CH	PEZZI/PIECES
<b>RC65M504</b>	4/2.7	M5	9	18,2	9	10
<b>RC65M506</b>	6/4	M5	9	18,5	9	10
<b>RC651806</b>	6/4	G1/8	15	21,5	12	10
<b>RC651406</b>	6/4	G1/4	17	23,5	12	10
<b>RC651808</b>	8/6	G1/8	15	21	14	10
<b>RC651408</b>	8/6	G1/4	14,5	24,5	14	10
<b>RC651410</b>	10/8	G1/4	17	25,5	16	10

## RC 66

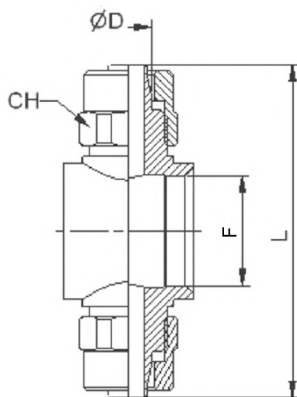

### 🇮🇹 Banjo doppio

- 🇬🇧 Banjo (double)
- 🇩🇪 Ringstück zweifach
- 🇫🇷 Raccord banjo double
- 🇪🇸 Racor banjo doble

CODICE/CODE	ØD	F"	L	CH	PEZZI/PIECES
<b>RC661806</b>	6/4	G1/8	43	12	10
<b>RC661406</b>	6/4	G1/4	50	12	10
<b>RC661808</b>	8/6	G1/8	43	14	10
<b>RC661408</b>	8/6	G1/4	50	14	10
<b>RC661410</b>	10/8	G1/4	53	16	10

## RC 72

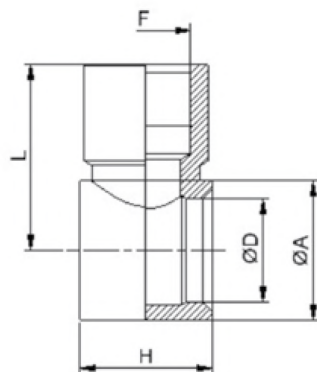

### 🇮🇹 Banjo filettato

- 🇬🇧 Female banjo
- 🇩🇪 Ringstück
- 🇫🇷 Raccord banjo fileté
- 🇪🇸 Racor banjo roscada

CODICE/CODE	ØD	F"	H	ØA	L	PEZZI/PIECES
<b>RC720018</b>	1/8	G1/8	15	7	20	10
<b>RC720014</b>	1/4	G1/4	17	8	24	10
<b>RC720038</b>	3/8	G3/8	20	10	28	10