

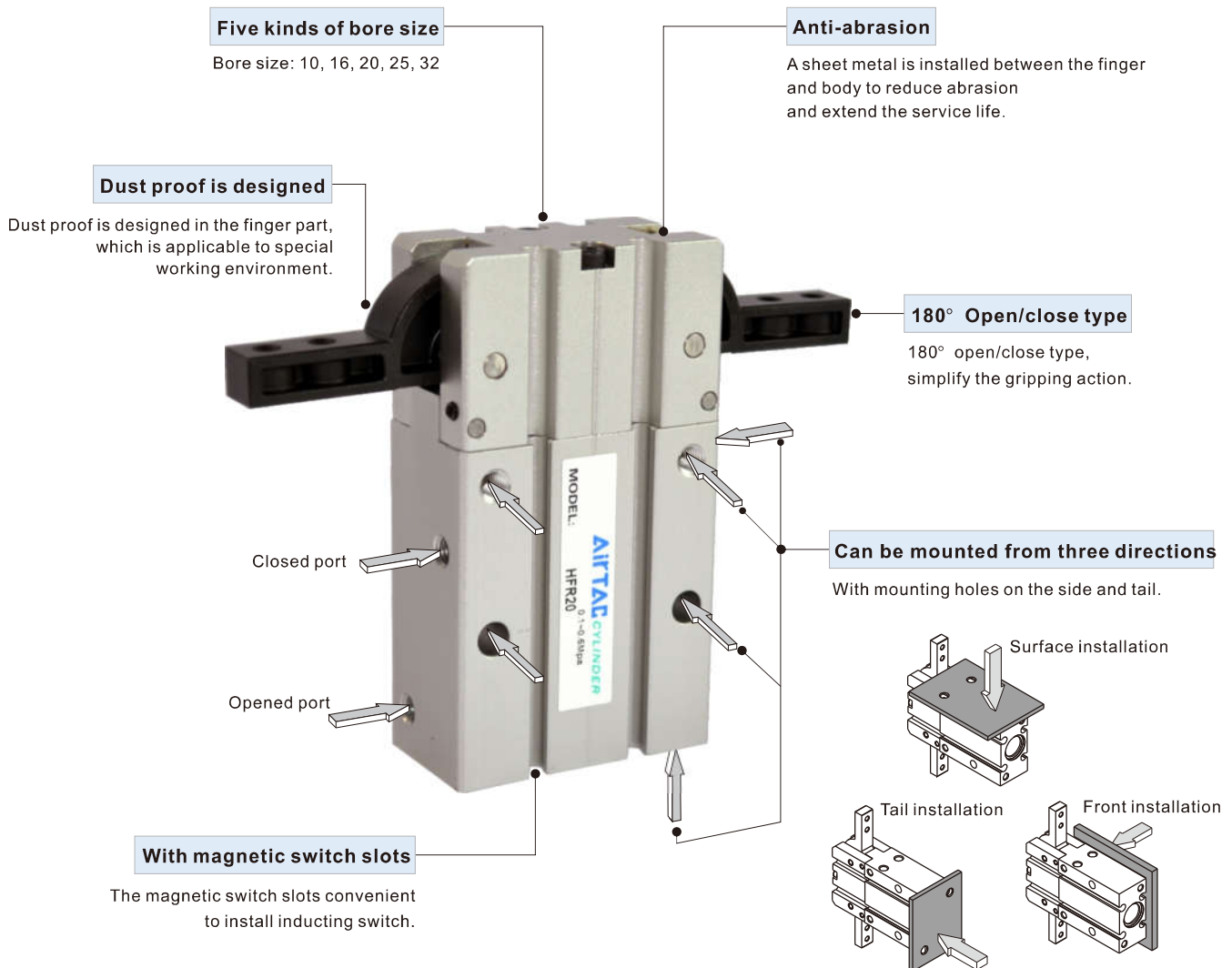

Air gripper—HFR Series

180° open/close style

Compendium of HFR Series



Bore size (mm)	10	16	20	25	32
Acting type	Double acting				
Fluid	Air(to be filtered by 40 μm filter element)				
Operating pressure	0.15~0.7MPa(21~100psi)(1.5~7.0bar)				
Temperature °C	-20~70				
Lubrication	Cylinder: Not required; Gripper jaws: Lubricate grease				
Cushion type	Bumper				
Max. frequency	60(c.p.m)				
Repeatability	±0.2mm				
Gripping force [Note1]	0.16N.m	0.55N.m	1.10N.m	2.30N.m	5.00N.m
Open or close angle	Open: -2° ~ -5° Close: 180° ± 2°				
Port size	M5×0.8				
Sensor switches [Note2]	CMSH/DMSH(S)				

[Note1] The gripping force is the value when the operating pressure is 0.5Mpa.

[Note2] Sensor switch should be ordered additionally, Refer to P451 for detail of sensor switch.

Example

Screw down

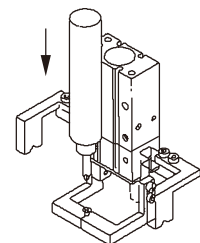

Clamping cable

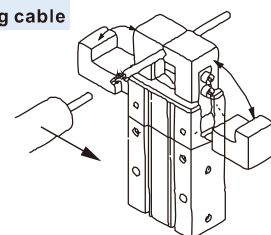

Air gripper(180° open/close style)

HFR Series



Symbol

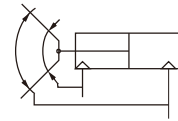

Ordering code

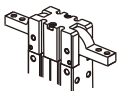
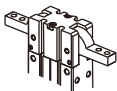
HFR 20 □			
	①	②	③
① Model	② Bore size	③ Mounting type	
HFR: 180° open/close air gripper	10 16 20 25 32	Blank: Mounting through tapped holes 	
		N: Mounting through holes (tapped in open/close direction) 	

[Note] HFR series are all attached with magnet.

Inner structure and material of major parts

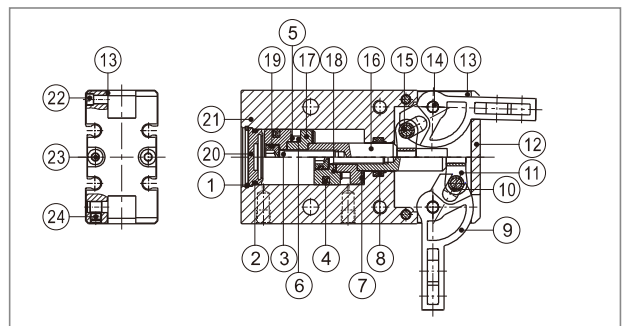

NO.	Item	Material	NO.	Item	Material
1	C clip	Spring steel	12	Front cover	Aluminum alloy
2	O-ring	NBR	13	Sheet metal	Stainless steel
3	Countersink screw	Carbon steel	14	Pin	Stainless steel
4	Piston seal	NBR	15	Pin	Stainless steel
5	Magnet washer	NBR	16	Piston rod	Stainless steel
6	Magnet	Sintered metal (Neodymium-iron-iron)	17	Magnet holder	Aluminum alloy
			18	Piston	Aluminum alloy
7	Bumper	TPU	19	O-ring	NBR
8	Rod packing	NBR	20	Back cover	Aluminum alloy
9	Gripping jaws	Stainless steel	21	Body	Aluminum alloy
10	Pin sheath	Stainless steel	22	Pin	Stainless steel
11	Push block	Stainless steel	23	Countersink screw	Carbon steel
			24	Countersink screw	Carbon steel

Dimensions

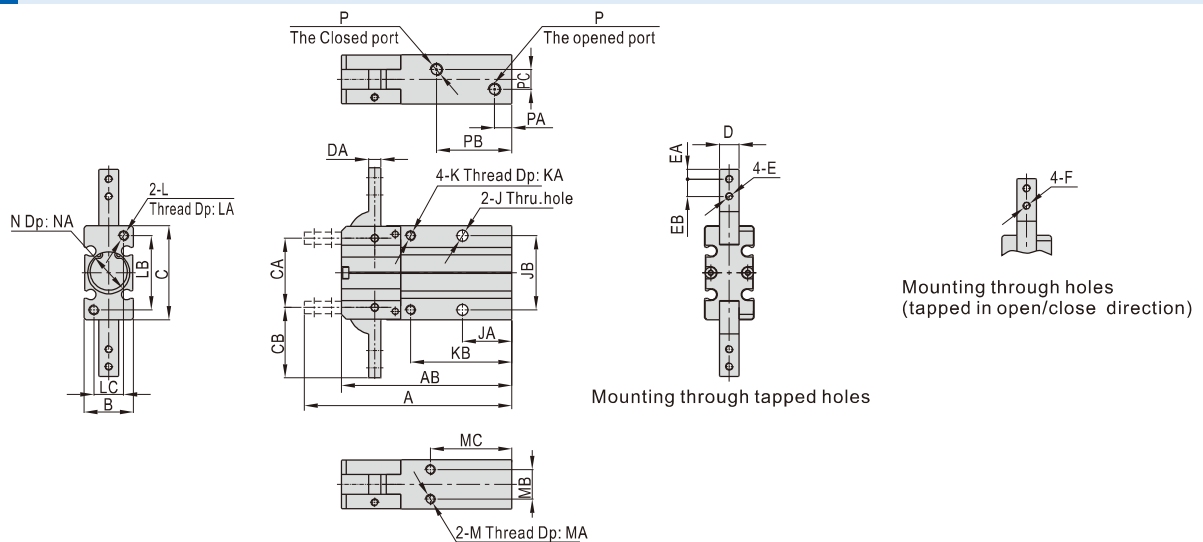

Bore size\Item	A	AB	B	C	CA	CB	D	DA	E	F	EA	EB	J	JA	JB	K	KA
10	71	58	15	30	22	23.5	6	4	M3×0.5	Φ3.3	3	6	Φ3.3	18	24	M3×0.5	6
16	84	69	20	38	28	28.5	8	5	M3×0.5	Φ3.3	4	7	Φ4.5	20	30	M4×0.7	8
20	106	86	26	48	36	37	10	8	M4×0.7	Φ4.5	5	9	Φ5.5	25	36	M5×0.8	10
25	131	107	30	58	45	45	12	10	M5×0.8	Φ5.5	6	12	Φ6.5	30	42	M6×1.0	12
32	158.5	122	40	72	55	62.5	14	12	M6×1.0	Φ6.5	9	16	Φ6.5	35	46	M6×1.0	12

Bore size\Item	KB	L	LA	LB	LC	M	MA	MB	MC	N	NA	P	PA	PB	PC
10	35	M3×0.5	6	24	9	M3×0.5	4	9	30	Φ11 ^{+0.05} ₀	1.5	M5×0.8	7	28.5	3
16	41	M4×0.7	8	30	12	M4×0.7	5	12	33	Φ17 ^{+0.05} ₀	1.5	M5×0.8	7	30.5	8
20	50	M5×0.8	10	38	16	M5×0.8	8	14	42	Φ21 ^{+0.05} ₀	1.5	M5×0.8	8	38.5	12
25	60	M6×1.0	12	46	18	M6×1.0	10	16	50	Φ26 ^{+0.05} ₀	1.5	M5×0.8	8	48	14
32	64	M6×1.0	14	46	26	M6×1.0	12	26	59	Φ34 ^{+0.05} ₀	2	M5×0.8	9	56	18

Air gripper(180° open/close style)

HFR Series

How to select product

1. Confirmation of effective gripping force

- 1.1) Though the coefficient of friction between the attachments and the workpiece is different, select a gripping force which is 10 to 20 times greater than the workpiece weight.
- 1.2) If high acceleration or impact forces are encountered during motion, a further margin of safety should be considered.

Example: When the workpiece weight is 0.05 and the gripping point distance L is 30mm, the operating pressure will be 5kgf/cm².

Effective gripping force=0.05kg×20 times×9.8m/s²=more than 10N

Model selection: HFR16 is recommended. The effective gripping force is 17N, which is 20 times greater than the set value of gripping force.

- 1.3) The finger thrust is expressed as F, when both fingers and attachments are in full contact with the workpiece as shown in the figure below.

2. Connection between gripping force and gripping point distance

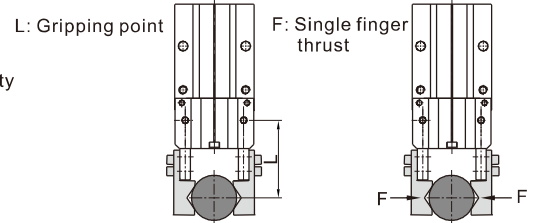
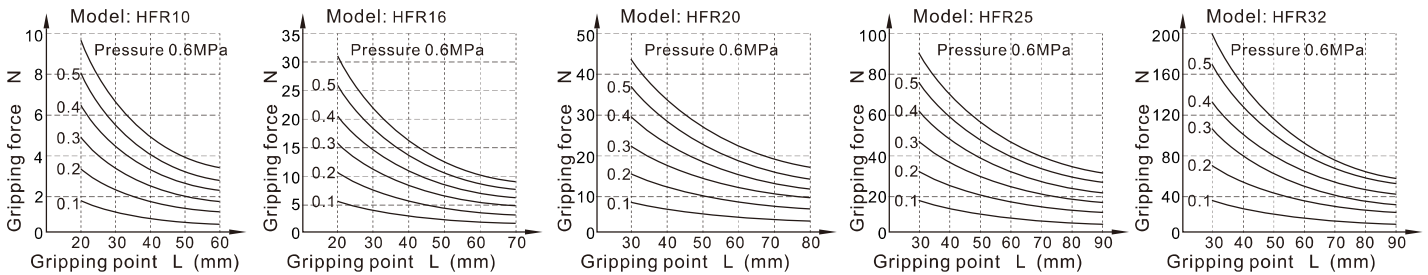

3. The selection of the gripping point

- 3.1) Please select the gripping point within the limited field shown left. Over the limits, gripping jaws would be subjected to excessive torque loads, and lead to short life of the air gripper.
- 3.2) In the allowable range of gripping point, it is better to design for short and light fittings. If the fittings are long and heavy, the inertia force when the finger is open and close will become larger, and the performance of gripping jaw will be degraded, at the same time it will affect the life.

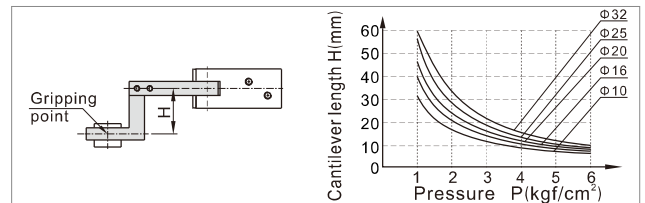

Installation and application

1. Due to the abrupt changes, the pressure is low, which will lead to the decrease of the gripping force and falling of the work-pieces. In order to avoid the harm to the human body and damage to the equipment, anti-dropping device must be equipped.
2. Don't use the air gripper under strong external force and impact force.
3. When install and fix the air gripper, avoid falling down, collision and damage.
4. When fixing the gripping jaw parts, don't twist the gripping jaw.
5. There are several kinds of installation method, and the torque of fastening screw must be within the prescribed moment range shown in the below chart. If the locking moment is too large, it will cause the dysfunctional. If the locking moment is too small, it will cause the position deviation and fall.

Tail installation type

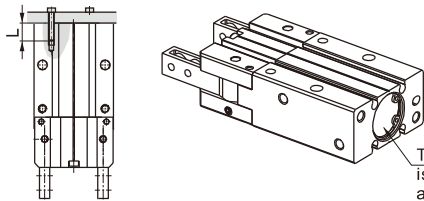

The bore of the tail is used for mounting and positioning

Bore size	The bolts type	Max. locking moment	Max. screwed depth	The aperture of the positioning bore	The depth of the positioning bore
10	M3×0.5	1.0N.m	6mm	Φ11mmH9	1.5mm
16	M4×0.7	2.0N.m	8mm	Φ17mmH9	1.5mm
20	M5×0.8	4.5N.m	10mm	Φ21mmH9	1.5mm
25	M6×1.0	7.0N.m	12mm	Φ26mmH9	1.5mm
32	M6×1.0	7.0N.m	14mm	Φ34mmH9	2.0mm

The installation of the front threaded hole

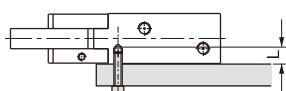

Bore size	The bolts type	Max. locking moment(Nm)	Max. screwed depth(mm)
10	M3×0.5	1.0	6
16	M4×0.7	2.0	8
20	M5×0.8	4.5	10
25	M6×1.0	7.0	12
32	M6×1.0	7.0	14

The installation of the front through hole

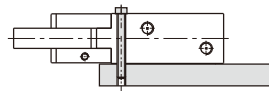

Bore size	The bolts type	Max. locking moment (Nm)
10	M3×0.5	1.0
16	M4×0.7	2.0
20	M5×0.8	4.5
25	M6×1.0	7.0
32	M6×1.0	7.0

Surface installation type

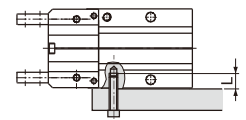

Bore size	The bolts type	Max. locking moment(Nm)	Max. screwed depth(mm)
10	M3×0.5	0.6	4
16	M4×0.7	1.5	5
20	M5×0.8	3.5	8
25	M6×1.0	6.0	10
32	M6×1.0	6.0	12

6. The installation method of the gripping jaw fittings. When install the gripping jaw fittings, you have to pay particular attention that you can only hold the gripping jaw by using spanner, and then lock the screws with allen wrench. Never clamp the body directly and then lock the screws, otherwise the parts will be easily damaged.

7. Other contents of installation and operation are the same with those of HFY. Refer to the "Installation and Operation" instruction of HFY.

Bore size	The bolts type	Max. locking moment (Nm)
10	M3×0.5	0.6
16	M3×0.5	0.6
20	M4×0.7	0.8
25	M5×0.8	1.5
32	M6×1.0	3.0

