



# Air gripper—HFKL Series

Parallel with guide/longer stroke/ball bearing style

## Compendium of HFKL Series

### Four kinds of bore size and three kinds of type

Bore size: 10, 16, 20, 25. HFKL: Double acting  
HFSKL: Single acting and normally closed  
HFTKL: Single acting and normally opened

### Long clamping stroke

The gripping stroke is long and the size of the gripping object is different.

### Integrated design of linear guide roller

Integrated design of linear guide roller, high rigidity and high precision.



Integration of a linear guide roller

### With positioning pin

A positioning pin is attached to the bottom of the linear guide rail, which can prevent the deviation of the positioning rail and body.

The positioning pin prevents the deviation of the rail and body

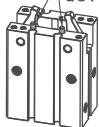

### Can be mounted from three directions

With mounting holes on the side and tail.

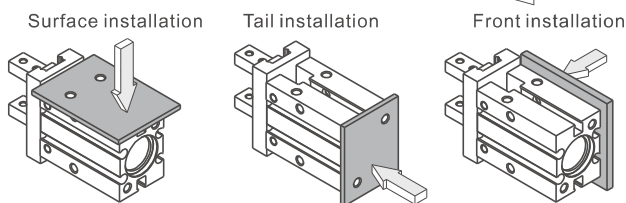

### With positioning hole

The positioning hole can improve the precision and the consistency of repeated dismounting and positioning.

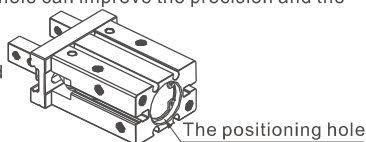

### Seven kinds of finger type

According to the actual using requirements of customers, the initial position of clamping jaw can be customized to meet the different needs under different working conditions.

#### Standard type

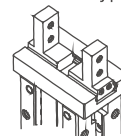

#### Side mounting type(B)

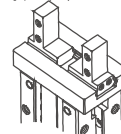

#### Thru.hole mounting type(N)

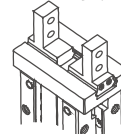

#### Bottom mounting type(F)

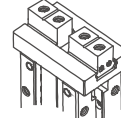

Closed port

Opened port

### With squareness magnetic switch slots

The squareness magnetic switch slots convenient to install DMSG(S)\CMSG type inducting switch.

### With roundness magnetic switch slots

The roundness magnetic switch slots convenient to install DMSH(S)\CMSH type inducting switch.

Bore size (mm)		10	16	20	25
Acting type		Double acting		Single acting	
Fluid		Air(to be filtered by 40μm filter element)			
Operating pressure	Double acting	Φ10	0.2~0.7MPa(28~100psi)(2.0~7.0bar)		
		Others	0.15~0.7MPa(22~100psi)(1.5~7.0bar)		
	Single acting	Φ10	0.35~0.7MPa(50~100psi)(3.5~7.0bar)		
		Others	0.25~0.7MPa(36~100psi)(2.5~7.0bar)		
Temperature °C		-20~70			
Lubrication		Not required			
Repeatability mm		±0.01			
Max. frequency		120(c.p.m)			
Sensor switches		DMSH(S)\CMSH	DMSG(S)\CMSG, MSH(S)\CMSH		
Port size		M3×0.5		M5×0.8	

Note) Refer to P519 for detail of sensor switch.



# Air gripper(Parallel with guide/longer stroke/ball bearing style) **AirTAC**

## HFKL Series

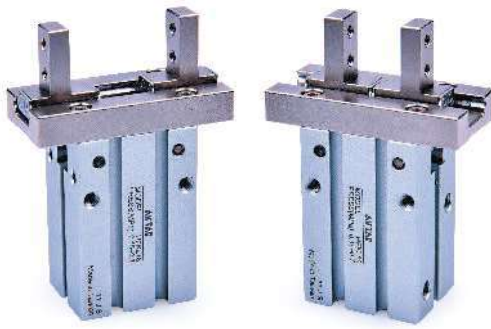

### Symbol

HFKL: Double acting

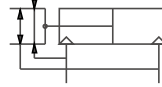

HFTKL: Single acting and normally opened

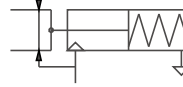

HFSKL: Single acting and normally closed

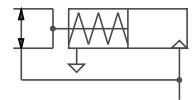

### Gripping force and stroke

Acting type		Double acting(HFKL)				Single acting_NO (HFTKL)				Single acting_NC (HFSKL)			
Bore size		10	16	20	25	10	16	20	25	10	16	20	25
Gripping force per finger Effective value(N)	External	11	34	45	69	7	27	35	55	-	-	-	-
	Internal	17	45	68	102	-	-	-	-	13	38	59	87
Opening/Closing stroke(Both sides)(mm)		8	12	18	22	8	12	18	22	8	12	18	22
Weight (g)	F Type	64	146	275	484	74	154	294	530	73	154	294	528
	Others	64	146	273	489	73	155	292	525	72	155	292	523

[Note] The gripping force in the above table is in the working pressure of 0.5MPa, and with a gripping point of L=20mm.  
Add) Please refer to page 444 for the definition of "L".

### Ordering code

HFKL 20 □

① ② ③

① Model	② Bore size	③ Finger type			
HFKL: Air finger(Double acting)	10 16 20 25	Blank: Standard	B: Side mounting type	N: Thru.hole mounting type	F: Bottom mounting type
HFSKL: Air finger (Single acting and normally closed)					
HFTKL: Air finger (Single acting and normally opened)					

[Note] HFKL series are all attached with magnet, and sensor switch should be ordered additionally.

### Inner structure and material of major parts

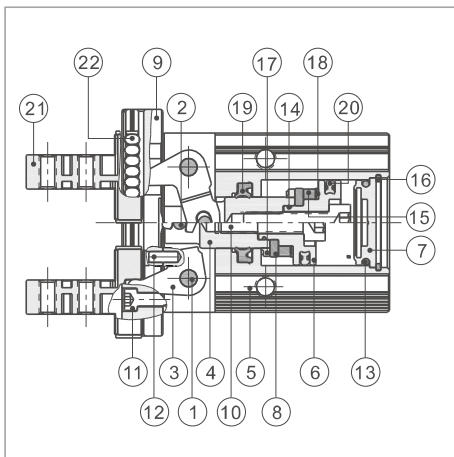

NO.	Item	Material	NO.	Item	Material
1	Pin	Stainless steel	12	Pin	Bearing steel
2	Pin	Stainless steel	13	O-ring	NBR
3	Curved bar	Stainless steel	14	O-ring	NBR
4	Piston rod	Aluminum alloy/Stainless steel	15	Magnet	Sintered metal(Neodymium-iron-boron)
5	Body	Aluminum alloy	16	C clip	Spring steel
6	Piston	Aluminum alloy/Stainless steel	17	Bumper	TPU
7	Back cover	Brass/Aluminum alloy	18	Magnet washer	NBR
8	Magnet fixed flake	Aluminum alloy/Stainless steel	19	Rod packing	NBR
9	Bearing steel	Stainless steel	20	Piston seal	NBR
10	Countersink screw	Carbon steel	21	Clamping jaw	Bearing steel
11	Countersink screw	Carbon steel	22	Guide roller	Bearing steel

# Air gripper(Parallel with guide/longer stroke/ball bearing style) **AirTAC**

## HFKL Series

### Dimensions

#### HFKL10

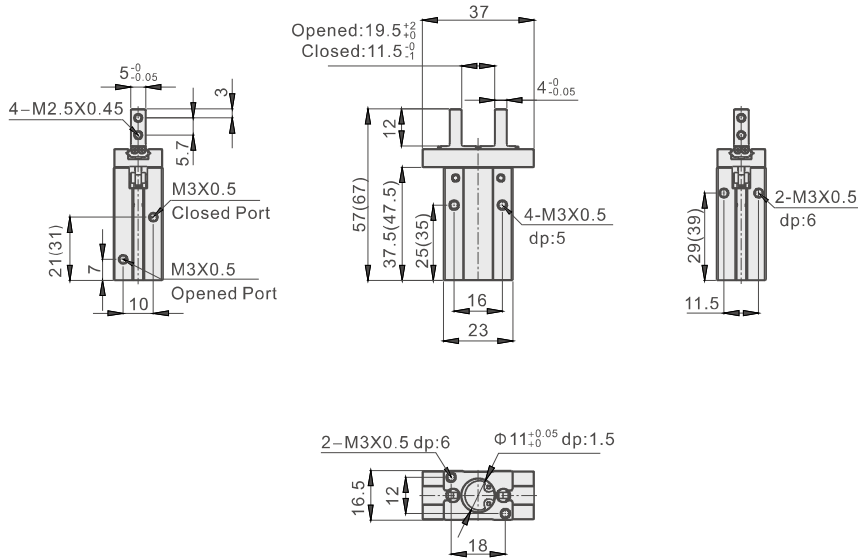

[Note]The values in "( )" in the above table are single acting type sizes.

#### Side mounting type(B type)

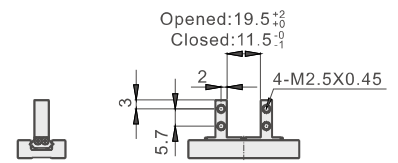

#### Thru-hole mounting type(N type)

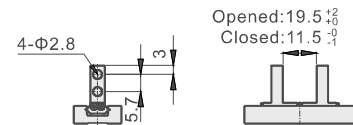

#### Bottom mounting type(F type)

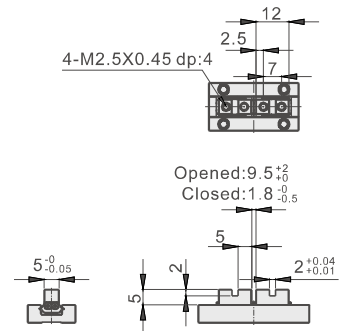

#### HFKL16

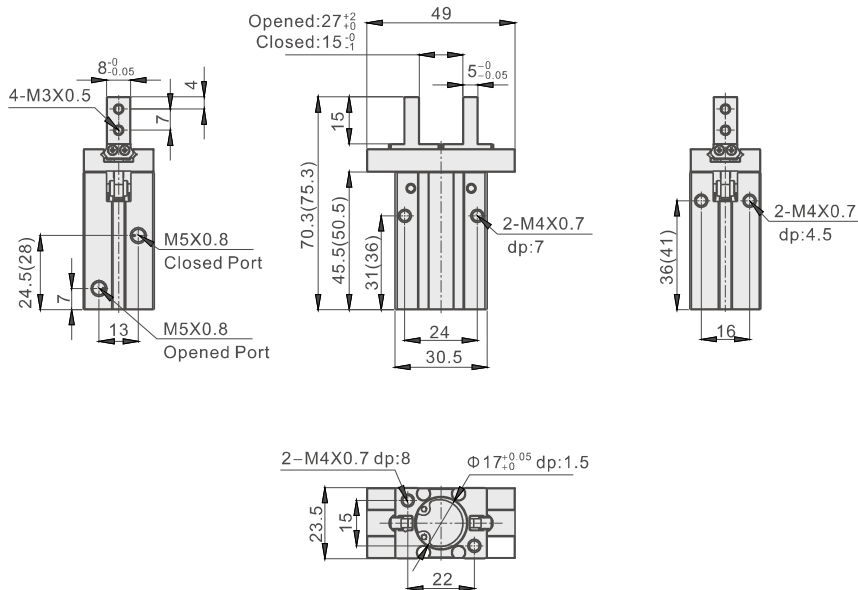

[Note]The values in "( )" in the above table are single acting type sizes.

#### Side mounting type(B type)

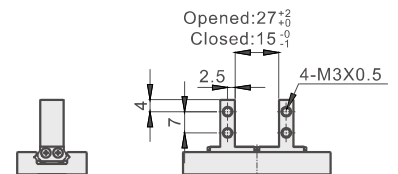

#### Thru-hole mounting type(N type)

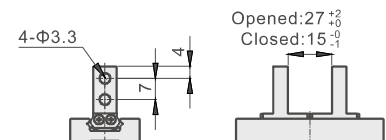

#### Bottom mounting type(F type)

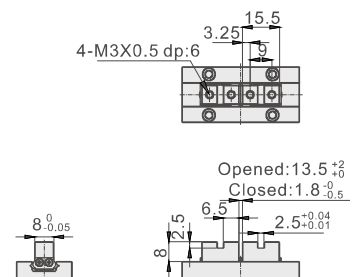

# Air gripper(Parallel with guide/longer stroke/ball bearing style) **AirTAC**

## HFKL Series

### HFKL20

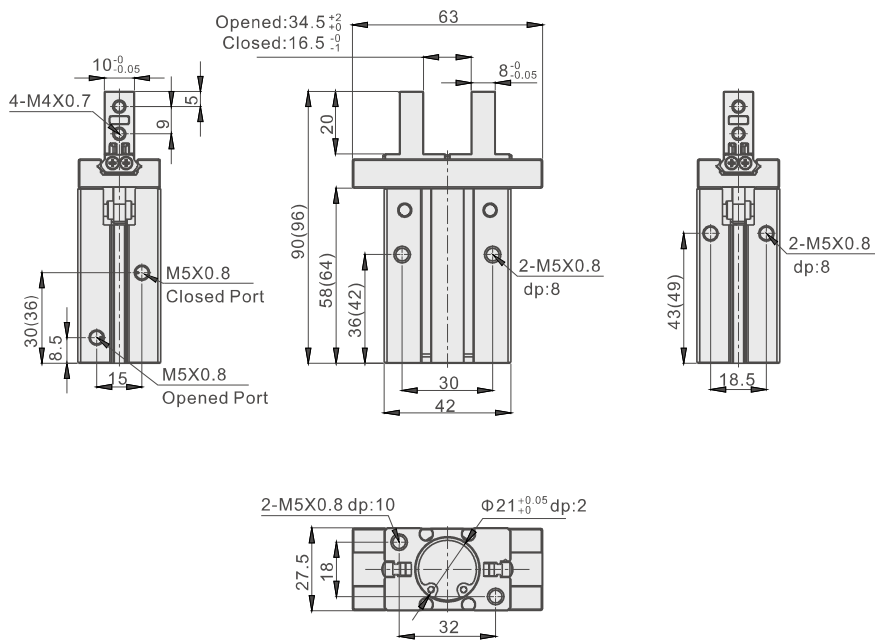

[Note]The values in "( )" in the above table are single acting type sizes.

### Side mounting type(B type)

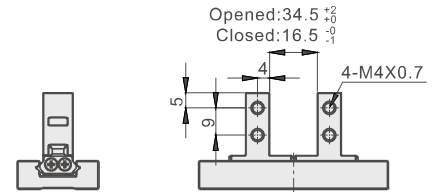

### Thru-hole mounting type(N type)

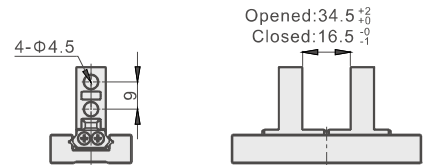

### Bottom mounting type(F type)

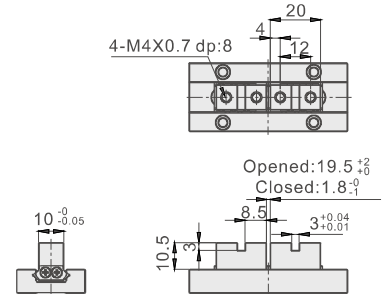

### HFKL25

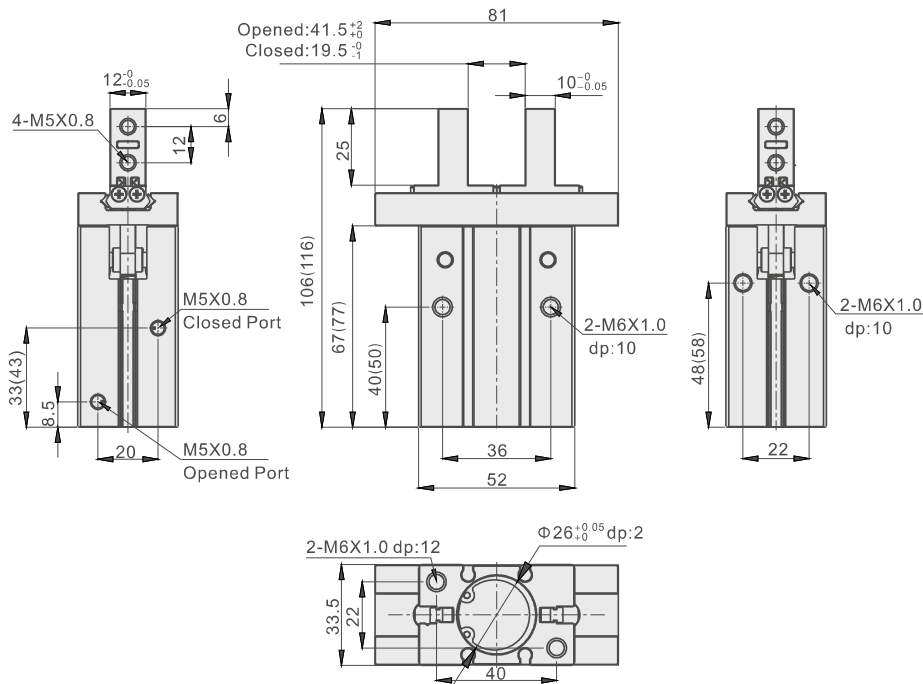

[Note]The values in "( )" in the above table are single acting type sizes.

### Side mounting type(B type)

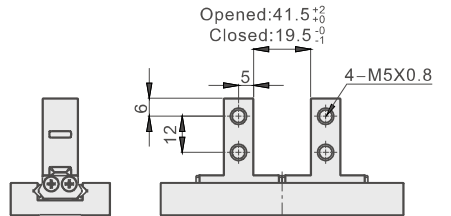

### Thru-hole mounting type(N type)

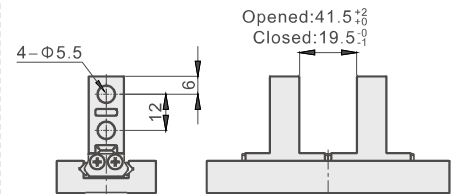

### Side mounting type(B type)

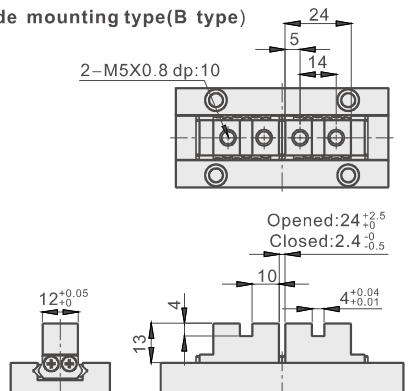

## HFKL Series

### How to select product

Please select pneumatic finger according to the following steps:

① The selection of the effective gripping force

② the confirmation of the gripping point

③ the confirmation of the external force put on the gripping jaw

1. The selection of the gripping force

The gripping work-pieces shown below, on the impact condition of ordinary handling state, taking safety coefficient a=4, have a gripping force that is more than 10-20 times of the mass of the gripped objects.

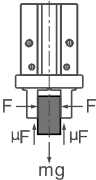
	The work-pieces as shown in the left :		μ = 0.2	μ = 0.1
	F: Gripping force (N) μ: friction coefficient between fittings and work-pieces. m: mass of work-pieces g: acceleration of gravity (=9.8m/s <sup>2</sup> )	The condition that the work-pieces won't drop is: $2 \times \mu F > mg$ so: $F > \frac{mg}{2 \times \mu}$ Safety coefficient is a, so F is: $F = \frac{mg}{2 \times \mu} \times a$	$F = \frac{mg}{2 \times 0.2} \times 4 = 10 \times mg$	$F = \frac{mg}{2 \times 0.1} \times 4 = 20 \times mg$
		10 times of the mass of the gripped objects	20 times of the mass of the gripped objects	

Note) If the friction coefficient  $\mu > 0.2$ , for safety, please also select clamping force according to the principle of 10~20 times of the mass of the clamped objects. As for large acceleration and shock, it requires for greater safety coefficient.

1.1) The actual gripping force must be within the effective gripping forces of different pneumatic fingers specifications shown in the below chart.

Double acting type closed gripping force

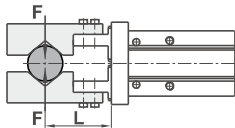

HFKL10

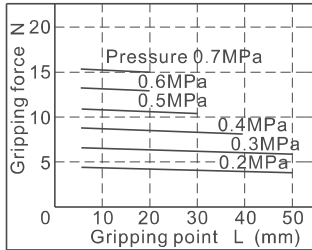

HFKL20

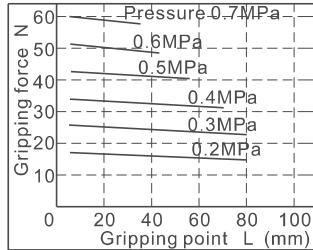

Double acting type opened gripping force

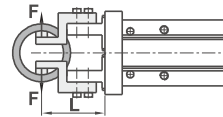

HFKL10

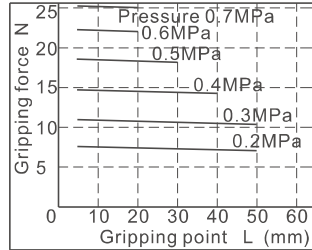

HFKL20

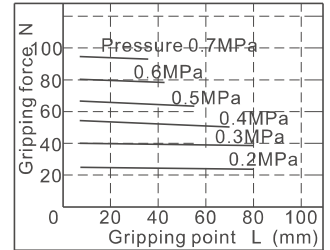

HFKL16

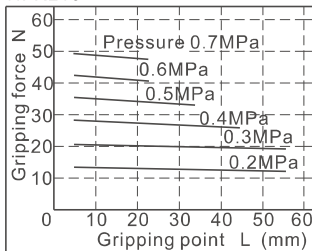

HFKL25

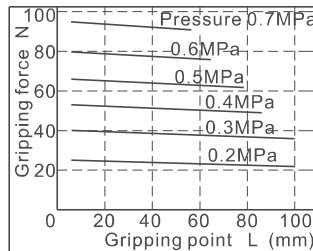

HFKL16

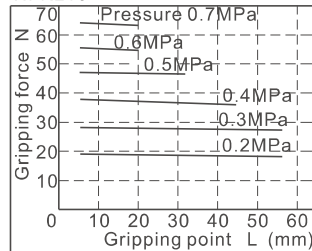

HFKL25

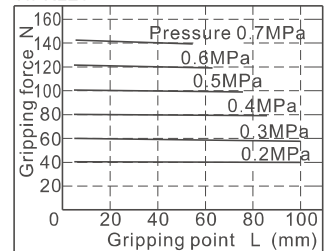

# Air gripper(Parallel with guide/longer stroke/ball bearing style) **AirTAC**

## HFKL Series

### Single acting normally opened gripping force

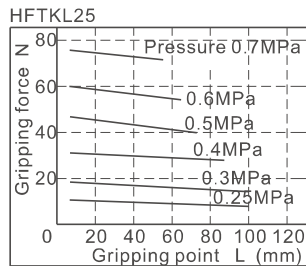
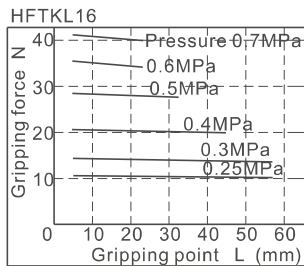
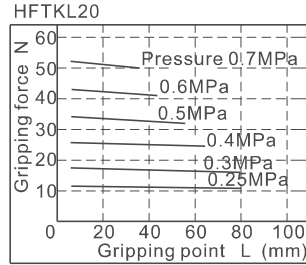
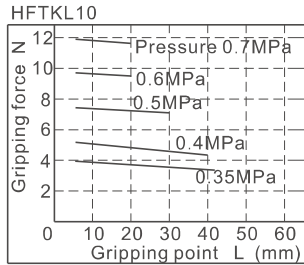
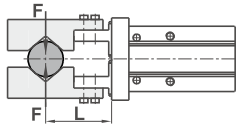

### Single acting normally closed clamping force

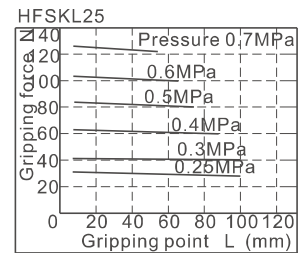
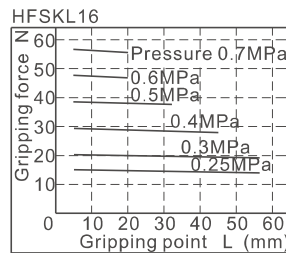
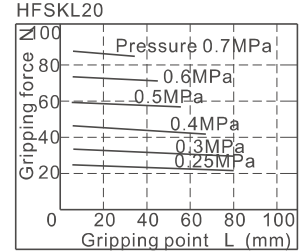
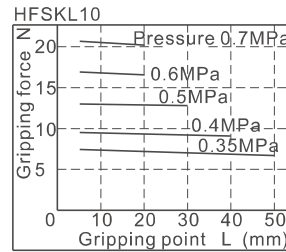
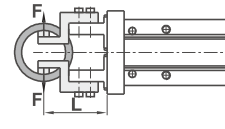

2. The selection of the gripping point

2.1) Please select the gripping point within the limited field shown below.

Over the limits, gripping jaws would be subjected to excessive torque loads, and lead to short life of the air gripper.

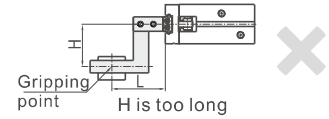
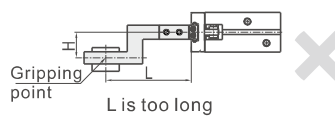
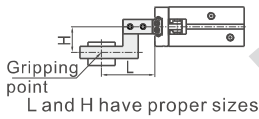

2.2) In the allowable range of gripping point, it is better to design for short and light fittings. If the fittings are long and heavy, the inertia force when the finger is open and close will become larger, and the performance of gripping jaw will be degraded, at the same time it will affect the life.

2.3) When the gripped object is very fine and thin, you have to equip with gap between fittings. If not, there will be unstable clamp, resulting in a position offset and adverse clamping and so on.

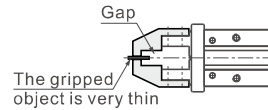
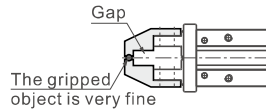

3. The confirmation of the external force put on the gripping jaw.

Bore size	The allowed vertical loads Fv(N)	Max. permissible torque(Nm)			The calculation of allowable forces when moment loads work	Examples of calculation
		Mp	My	Mr		
10	87	0.26	0.26	0.53	$\frac{M(\text{Maximum permissible moment})(\text{N.m})}{L \times 10^{-3}}$ Unit conversion constant	In the guide rail of HFKL16, the external force of the pitching moment static loads put on the point of L=30mm is f=10 N, Allowable load F= 0.68/(30×10 <sup>-3</sup> ) = 22.7(N) Actual load f=10(N)<22.7(N) To meet the using requirements
16	147	0.68	0.68	1.36		
20	221	1.32	1.32	2.65		
25	382	1.94	1.94	3.88		

[Note] The loads and torque values of said are all static values.

# Air gripper(Parallel with guide/longer stroke/ball bearing style) **AirTAC**

## HFKL Series

The range of the closed gripping points

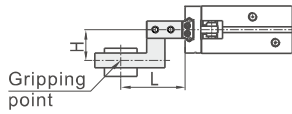

HFKL10

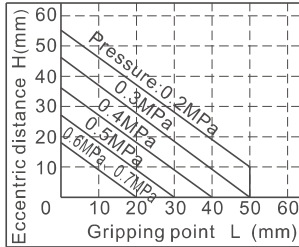

HFKL20

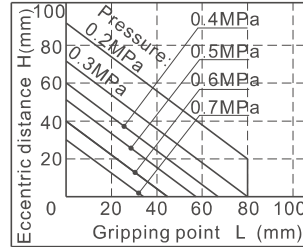

The range of the opened clamping point

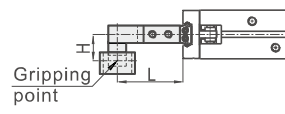

HFKL10

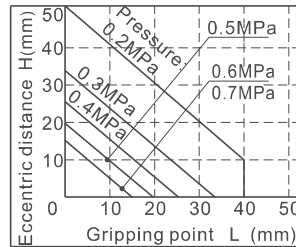

HFKL20

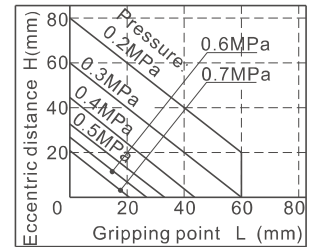

HFKL16

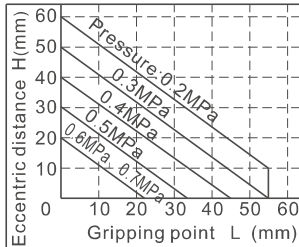

HFKL25

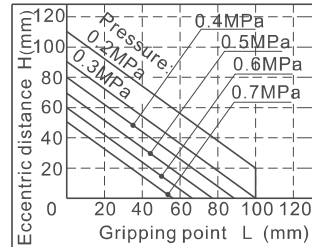

HFKL16

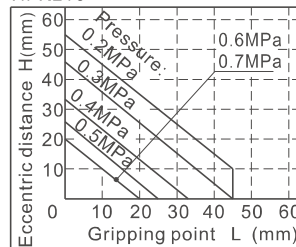

HFKL25

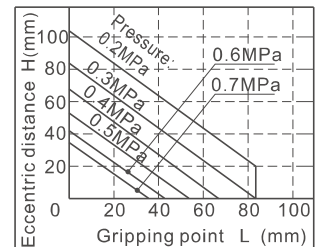

## Installation and application

- Due to the abrupt changes, the circuit pressure is low, which will lead to the decrease of the gripping force and falling of the work-pieces. In order to avoid the harm to the human body and damage to the equipment, anti-dropping device must be equipped.
- Don't use the air gripper under strong external force and impact force.
- Please contact with us when the single acting type clamps only with the spring force.
- When install and fix the air gripper, avoid falling down, collision and damage.
- When fixing the gripping jaw parts, don't twist the gripping jaw.
- There are several kinds of installation method, and the locking torque of fastening screw must be within the prescribed torque range shown in the below chart. If the locking torque is too large, it will cause the dysfunctional. If the locking torque is too small, it will cause the position deviation and fall.

### Tail installation type

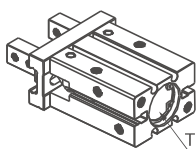
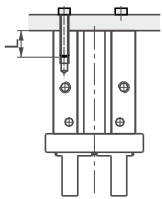

The bore of the tail is used for mounting and positioning

Bore size	The bolts type	Max. locking moment	Max. screwed depth	The aperture of the positioning bore	The depth of the positioning bore
10	M3×0.5	0.88N.m	6mm	Φ11mm <sup>+0.05</sup> <sub>0</sub>	1.5mm
16	M4×0.7	2.1N.m	8mm	Φ17mm <sup>+0.05</sup> <sub>0</sub>	1.5mm
20	M5×0.8	4.3N.m	10mm	Φ21mm <sup>+0.05</sup> <sub>0</sub>	2mm
25	M6×1.0	7.3N.m	12mm	Φ26mm <sup>+0.05</sup> <sub>0</sub>	2mm

### The installation of the front threaded hole

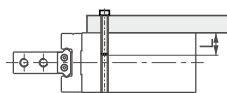

Bore size	The bolts type	Max. locking moment(Nm)	Max. screwed depth(mm)
10	M3×0.5	0.69	5
16	M4×0.7	2.1	7
20	M5×0.8	4.3	8
25	M6×1.0	7.3	10

### The installation of the front through hole

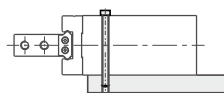

Bore size	The bolts type	Max. locking moment (Nm)	Max. screwed depth (mm)
10	M2.5×0.45	0.49	5
16	M3×0.5	0.88	8
20	M4×0.7	2.1	10
25	M5×0.5	4.3	12

### Surface installation type

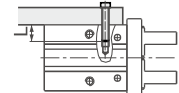

Bore size	The bolts type	Max. locking moment (Nm)	Max. screwed depth (mm)
10	M3×0.5	0.9	6
16	M4×0.7	1.6	4.5
20	M5×0.8	3.3	8
25	M6×1.0	5.9	10

# Air gripper(Parallel with guide/longer stroke/ball bearing style) **AirTAC**

## HFKL Series

### 7. The installation method of the gripping jaw fittings

When install the gripping jaw fittings, you have to pay particular attention that you can only hold the gripping jaw by using spanner, and then lock the screws with allen wrench. Never clamp the body directly and then lock the screws, otherwise the parts will be easily damaged.

Bore size	The bolts type	Max. locking moment (Nm)
10	M2.5×0.45	0.31
16	M3×0.5	0.59
20	M4×0.7	1.4
25	M5×0.8	2.8

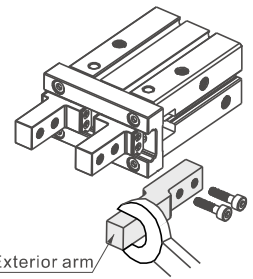

Exterior arm

### 8. Confirm that there is no external forces exerted on the gripping jaw.

Transverse load acts on the gripping jaw, which will cause impact load and leads to the shaking and damage of gripping jaw. Equip with gaps so that the air gripper will not crash into work-pieces and accessories at the end of its trip.

#### 8.1) The end of stroke under the open state of air gripper

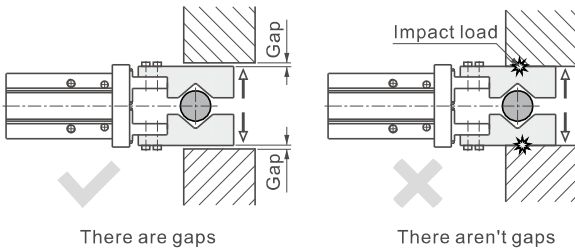

#### 8.2) The end of stroke under the move state of air gripper

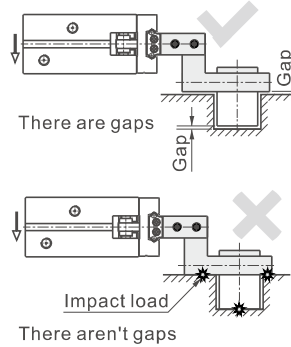

#### 8.3) Reverse motion state

When reverse motion state, the gripping point must be precision, otherwise in the reverse motion state the air gripper maybe impact with ambience and will cause impact load.

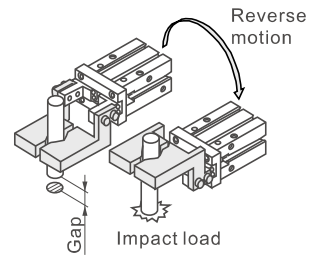

9. When the work-pieces are inserted, the center line should be coaxial, no offset, in case there are external force generated on gripping jaw. When testing, it is specially required that the manual operation should be reduced, the pressure should be used to run it at a low speed, and guarantee the safety and no impact.



10. Please use the flow control valve to adjust the opening and closing speed of gripping jaw if too fast.

11. People can not enter the movement path of air gripper and articles can not be placed on the path too.

12. Before removing the air gripper, please confirm that it is out of working state, and then discharge of compressed air.