

















-  **Giunti ed innesti Italia**
-  Italy couplings and plugs
-  Kupplungen Italien
-  Raccords à coiffe Italie
-  Enchufe Italia

GN10**GN20****GN30****GN40****GN50****GN60****GN60T****GN60OR****GN70****GN70T****GN80****GN85****GN90****GN95****GN97**

-  **Dati tecnici di giunti ed innesti Italia**
-  Italy couplings and plugs technical data
-  Technischen Daten der Kupplungen Italien
-  Données techniques des raccords à coiffe Italie
-  Datos técnicos de los enchufe Italia

-  **Caratteristiche principali**
- 1. Gamma completa 1/8 – 1/2"
- 2. Filettatura BSPP cilindrica UNI-ISO228, BSPT conica UNI-ISO 7
- 3. Vasta gamma
- 4. Robustezza meccanica
-  **Principales caractéristiques**
- 1. Gamme complète 1/8 - 1/2"
- 2. Filetage cylindrique BSPP UNI-ISO 228, conique BSPT UNI-ISO 7
- 3. Large gamme
- 4. Résistance mécanique

-  **Main features**
- 1. Complete Range 1/8 - 1/2"
- 2. BSPP cylindrical thread UNI-ISO 228, conical BSPT UNI-ISO 7
- 3. Wide range
- 4. Mechanical Resistance
-  **Características principales**
- 1. Gama completa 1/8-1/2"
- 2. BSPP rosca cilíndrica UNI-ISO 228, cónica BSPT UNI-ISO 7
- 3. Amplia gama
- 4. Robustez mecánica

-  **Hauptmerkmale**
- 1. Vollständiges Sortiment 1/8 - 1/2"
- 2. BSPP-zylindrisches Gewinde UNI-ISO 228, konisch BSPT UNI-ISO 7
- 3. Große Auswahl
- 4. Mechanische Festigkeit

-  **Applicazioni**
- 1. Aria Compressa
- 2. Impianti per automazione pneumatica
- 3. Gas inerti
- 4. Vuoto

-  **Applications**
- 1. Air comprimé
- 2. Installations pour l'automatisation pneumatique
- 3. Gaz neutres
- 4. Vide

-  **Applications**
- 1. Compressed Air
- 2. Systems for pneumatic automation
- 3. Inert Gases
- 4. Vacuum

-  **Aplicaciones**
- 1. Aire comprimido
- 2. Instalaciones para automación neumática
- 3. Gases inertes
- 4. Vacío

-  **Anwendungen**
- 1. Druckluft
- 2. Systeme für die pneumatische Automatisierung
- 3. Inertgase
- 4. Leer

 **Fluido**
Acqua, olio, aria compressa

 **Fluid**
Water, oils, compressed air

 **Fluid**
Wasser, oel, druckluft

 **Fluide**
Eau, huile, air comprimé

 **Fluido**
Agua, aceite, aire comprimido

 **Filettatura**
BSPP cilindrica UNI-ISO228

 **Thread types**
BSPP parallel UNI-ISO228

 **Gewinde**
BSPP zylindrisch UNI-ISO228

 **Filetage**
BSPP cylindrique UNI-ISO228

 **Roscado**
BSPP cilindrico UNI-ISO 228

 **Filetti**
Filettature da 1/8 a 1/2"

 **Threads**
Threads from 1/8 to 1/2"

 **Gewinde**
Gewinde von 1/8 bis 1/2"

 **Filets**
Filetages de 1/8 à 1/2"

 **Roscas**
Roscas de 1/8 a 1/2"



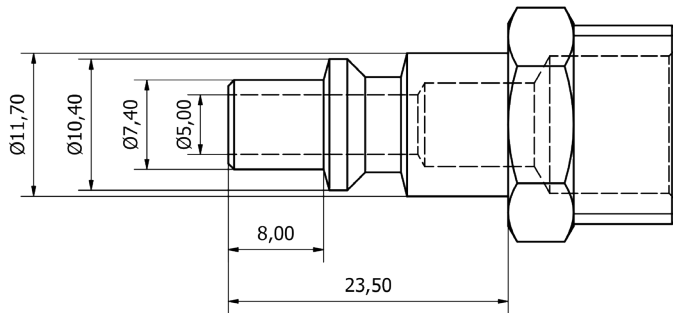

 Pressione e temperatura	 Pressure and Temperature	 Druck und Temperatur	 Pression et Température	 Presión y Temperatura
Pressione: 12 Bar	Pressure: 12 Bar	Druck: 12 Bar	Pression: 12 bar	Presión: 12 Bar
Temperatura: -18°C / +80°C	Temperature: 0°F / +176°F	Temperatur: -18°C / +80°C	Température: -18°C / +80°C	Temperatura: -18°C / +80°C

 Portata	 Flow	 Mengenstrom	 Débit	 Caudal
Portata: 1600 l/min.	Flow: 1600 l/min.	Mengenstrom: 1600 l/min.	Débit: 1600 l/min.	Caudal: 1600 l/min.

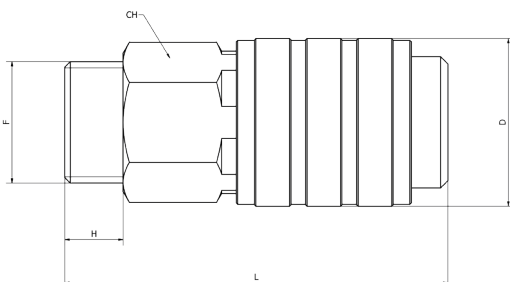

GN 10





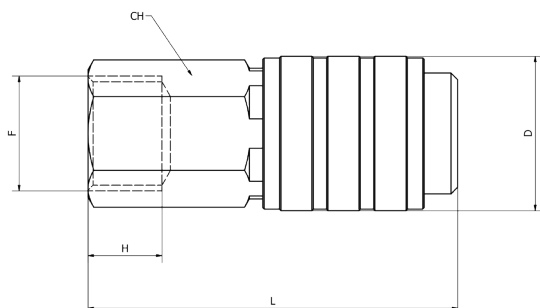

 **Giunto Italia maschio**
 Italian male quick coupler
 Kupplungen Italien
 Coupleurs mâle Italia
 Enchufe macho Italia

CODICE/CODE	F	H	D	L	CH	PEZZI/PIECES
GN100018	G1/8	6,5	23	51	19	10
GN100014	G1/4	8	23	52,5	19	10
GN100038	G3/8	8	23	52,5	19	10
GN100012	G1/2	10	23	56	22	10

GN 20





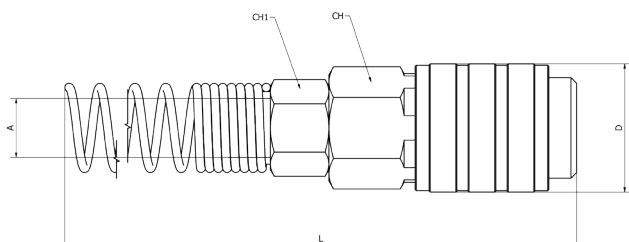

-  **Giunto Italia femmina**
-  Italian female quick coupler
-  Kupplungen Italien
-  Coupleurs femelle Italia
-  Enchufe hembra Italia

CODICE/CODE	F	H	D	L	CH	PEZZI/PIECES
GN200018	G1/8	8	23	52,5	19	10
GN200014	G1/4	10	23	52,5	19	10
GN200038	G3/8	11	23	55	19	10
GN200012	G1/2	12,5	23	56,5	25	10

GN 30





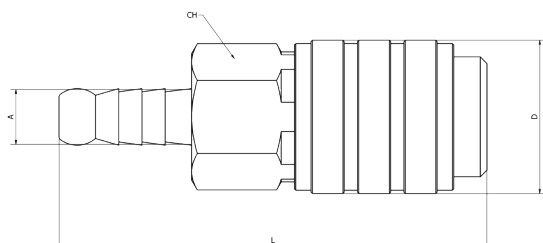

-  **Giunto Italia con molla**
-  Italian female quick coupler with spring
-  Kupplungen Italien mit Feder
-  Coupleurs Italia avec ressort
-  Enchufe Italia con muelle

CODICE/CODE	A	D	L	CH	CH1	PEZZI/PIECES
GN300406	04x06	23	129,5	19	12	10
GN300508	05x08	23	140,5	19	13	10
GN300608	06x08	23	140,5	19	13	10
GN306510	6,5x10	23	140	19	15	10
GN300810	08x10	23	141	19	15	10
GN300812	08x12	23	142	19	17	10
GN301012	10x12	23	141	19	17	10

GN 40



-  **Giunto Italia con resca**
-  Italian quick coupler with tail
-  Kupplungen Italien mit Abschluss
-  Coupleurs Italia barbillon
-  Enchufe Italia con espiga

CODICE/CODE	A	D	L	CH	PEZZI/PIECES
GN400006	6	23	62,5	19	10
GN400008	8	23	64,5	19	10
GN400010	10	23	64,5	19	10
GN400012	12	23	64,5	19	10

GN 50

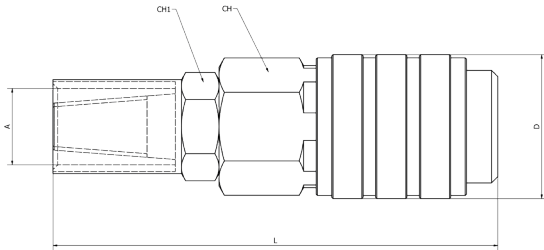

Giunto Italia portagomma

Italian quick coupler for rubber hose

Schlauchtulle Kupplungen Italien

Coupleurs Italia pour tuyau

Enchufe Italia para tubo

CODICE/CODE	A	D	L	CH	CH1	PEZZI/PIECES
GN500610	06x10	23	70	19	15	10
GN500612	06x12	23	71	19	15	10
GN500613	06x13	23	71	19	16	10
GN500614	06x14	23	71	19	17	10
GN500812	08x12	23	71	19	15	10
GN500817	08x17	23	71,5	19	20	10
GN501015	10x15	23	73,5	19	18	10
GN501017	10x17	23	73,5	19	20	10
GN501019	10x19	23	76,5	19	22	10

GN 60

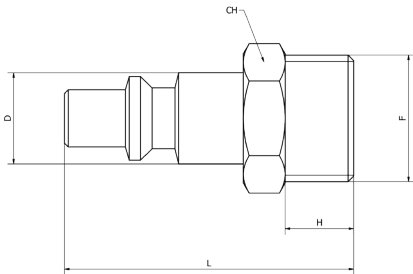

Innesto maschio Italia

Italian male connection

Kupplungen Italien

Embout mâle Italia

Adaptador macho Italia

CODICE/CODE	F	H	D	L	CH	PEZZI/PIECES
GN600018	G1/8	6,5	12	35	13	10
GN600014	G1/4	8,5	12	38	14	10
GN600038	G3/8	9,5	12	38	17	10
GN600012	G1/2	11	12	40	22	10

GN 60T

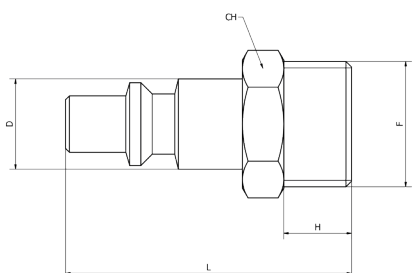

Innesto maschio Italia (acciaio temperato)

Italian male connection (tempered steel)

Kupplungen Italien (Gehärtete Edelstahl)

Embout mâle Italia (acier trempé)

Adaptador macho Italia (acero templado)

CODICE/CODE	F	H	D	L	CH	PEZZI/PIECES
GN600018T	G1/8	6,5	12	35	13	10
GN600014T	G1/4	8,5	12	38	14	10
GN600038T	G3/8	9,5	12	38	17	10
GN600012T	G1/2	11	12	40	22	10

GN 60OR

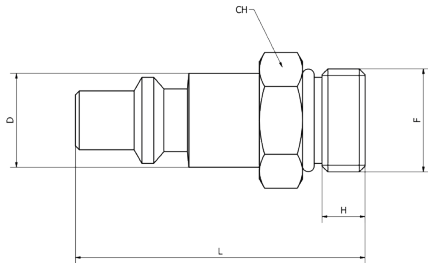

 **Innesto maschio Italia con O-ring**

 Italian male connection with O-ring

 Kupplungen Italien mit O-Ring

 Embout mâle Italia avec O-ring

 Adaptador macho Italia con O-ring

CODICE/CODE	F	H	D	L	CH	PEZZI/PIECES
GN600014OR	G1/4	8	12	37	15	10

GN 70

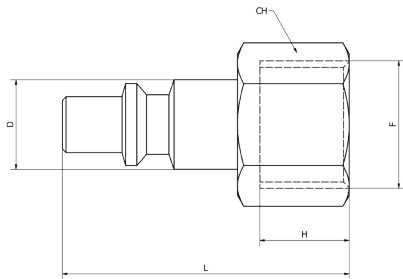

 **Innesto Italia femmina**

 Italian female connection

 Kupplungen Italien

 Embout femelle Italia

 Adaptador hembra Italia

CODICE/CODE	F	H	D	L	CH	PEZZI/PIECES
GN700018	G1/8	8,5	12	29	13	10
GN700014	G1/4	10,5	12	37	15	10
GN700038	G3/8	11,5	12	38,5	19	10
GN700012	G1/2	14,5	12	41	25	10

GN 70T

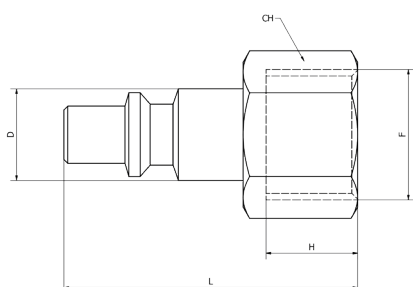

 **Innesto femmina Italia (acciaio temperato)**

 Italian female connection (tempered steel)

 Kupplungen Italien (Gehärtete Edelstahl)





 Embout femelle Italia (acier trempé)

 Adaptador hembra Italia (acero templado)

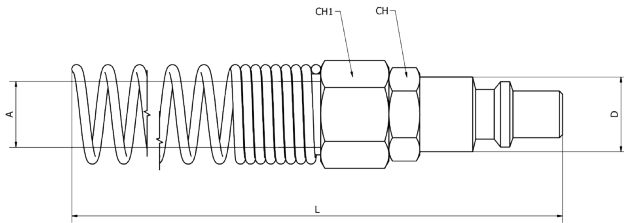
CODICE/CODE	F	H	D	L	CH	PEZZI/PIECES
GN700014T	G1/4	11	12	37	15	10
GN700038T	G3/8	12	12	38	19	10

GN 80





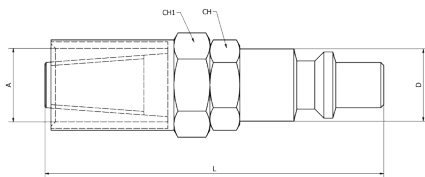

-  **Innesto Italia con molla**
-  Italian spring connection
-  Kupplungen Italien mit Feder
-  Embout Italia avec ressort
-  Adaptador Italia con muelle

CODICE/CODE	A	D	L	CH	CH1	PEZZI/PIECES
GN800406	04x06	12	120	13	12	10
GN800508	05x08	12	124	13	13	10
GN800608	06x08	12	124	13	13	10
GN806510	6,5x10	12	124	13	15	10
GN800810	08x10	12	124	13	15	10
GN800812	08x12	12	126	15	17	10
GN801012	10x12	12	126	15	17	10

GN 85





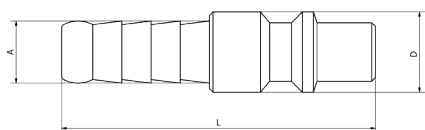

-  **Innesto Italia portagomma**
-  Italian connection for rubber tube
-  Schlauchtulle Kupplungen Italien
-  Embout Italia pour tuyau
-  Adaptador Italia para tubo

CODICE/CODE	A	D	L	CH	CH1	PEZZI/PIECES
GN850610	06x10	12	55,5	13	15	10
GN850612	06x12	12	55,5	13	15	10
GN850613	06x13	12	55,5	13	16	10
GN850614	06x14	12	55,5	13	17	10
GN850812	08x12	12	56,5	13	15	10
GN850813	08x13	12	56,5	13	16	10
GN850815	08x15	12	56,5	13	18	10
GN850817	08x17	12	56,5	13	20	10
GN851015	10x15	12	58	13	18	10
GN851017	10x17	12	58	13	20	10
GN851019	10x19	12	60	13	22	10

GN 90



-  **Innesto Italia con resca**
-  Italian connection with tail
-  Kupplungen Italien mit Abschluss
-  Embout Italia barbillon
-  Adaptador Italia con espiga

CODICE/CODE	A	D	L	PEZZI/PIECES
GN900006	6	12	43	10
GN900007	7	12	43	10
GN900008	8	12	45	10
GN900010	10	12	45	10
GN900012	12	12	48	10

GN 95

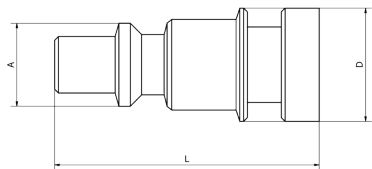

 **Innesto Italia baionetta**

 Italian bayonet connection

 Kupplungen Italien mit Bajonett

 Embout Italia baïonnette

 Adaptador Italia bayoneta

CODICE/CODE	A	D	L	PEZZI/PIECES
GN950000	10,5	15	35	10

GN 97

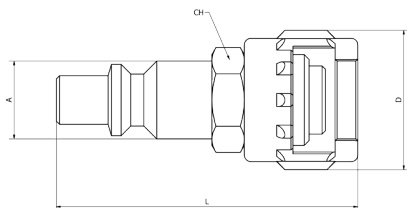

 **Innesto Italia con dado fresato**

 Italian connection with milled nut

 Kupplungen Italien mit Mutter

 Embout Italia avec écrou fraise

 Adaptador Italia con tuerca fresada

CODICE/CODE	A	D	L	CH	PEZZI/PIECES
GN970000	12	21,5	46	14	10