

Limit Switches EM series

Summary

APPROVALS: UL 508 / CSA C22-2 N. 14 / IEC 60947-5-1



CB-SCHEME certification according to IEC 60947-5-1

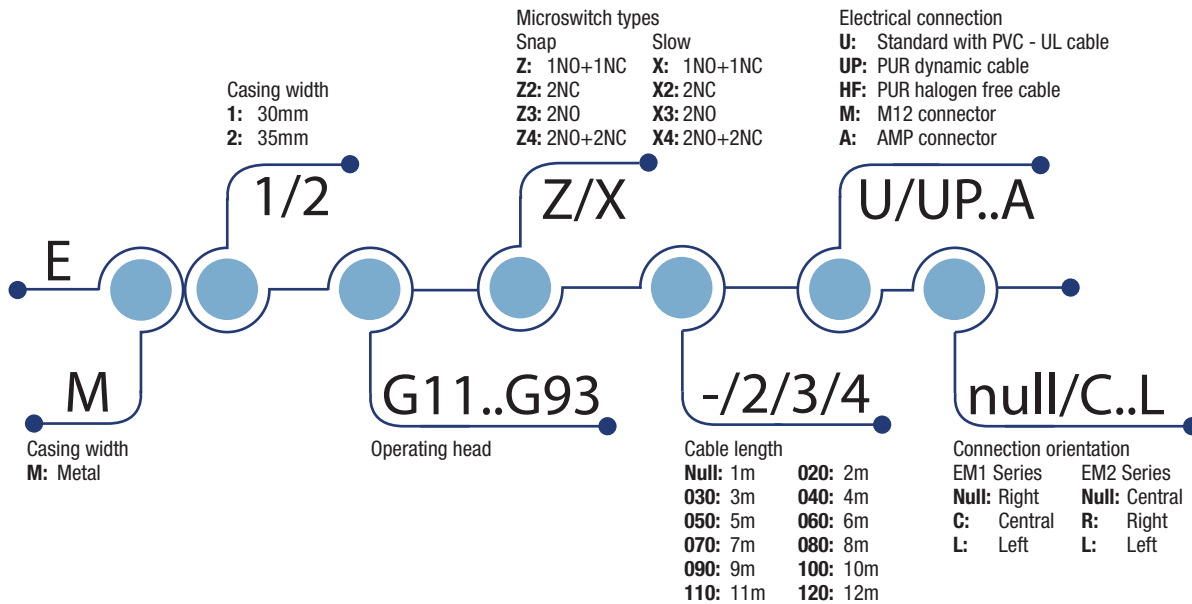

HOW IS IT MADE?

01 A variety of actuators

- Plain plunger
- Roller plunger
- Roller lever, adjustable or not, etc.

02 Wide range of heads

- Assembled using 2 x Ø3 screws or 2 plug

03 Casing:

- 30 or 35 mm. width

04 Mounting screws

- 2 x M4 screws on top part

05 Epoxy resin for IP67 protection degree

06 Contact Block

- Positive opening operation
- Snap action or slow action
- Electrically separated contacts

07 Connecting terminals

- Cable: PVC 4 x 0,75 mm²
- Special cables: Halogen Free or Dynamic PUR
- M12 connector
- AMP connector

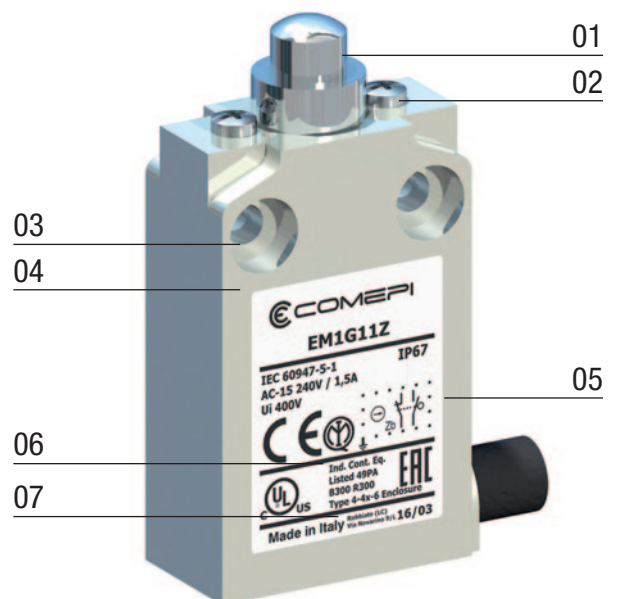

Limit Switches **EM series**

Description

APPLICATIONS

Easy to use, electromechanical limit switches offer specific qualities:

- Visible operation.
- Able to switch strong currents (up to 10 A conventional thermal current).
- Electrically separated contacts.
- Precise operating points (consistency).
- Immune to electromagnetic disturbances.

They are purpose-built detection devices thanks to these characteristics:

- Presence/absence.
- Positioning and travel limit.
- Objects passing/counting.

DESCRIPTION

These limit switches, made zinc alloy (Zamak), sealed with epoxy resin at the base on the box, offer a degree of protection IP67.

The casing come in 2 dimensions: – EM1... 30 mm. width – EM2... 35 mm. width

They comply with the requirements of European Directives (Low Voltage and RoHS) and are conform to European and International Standards.

The CE declaration of these products are available in the download section of website www.comepi.it or by writing to the following email address: tecnico@comepi.it
DDC02 - Limit Switches.

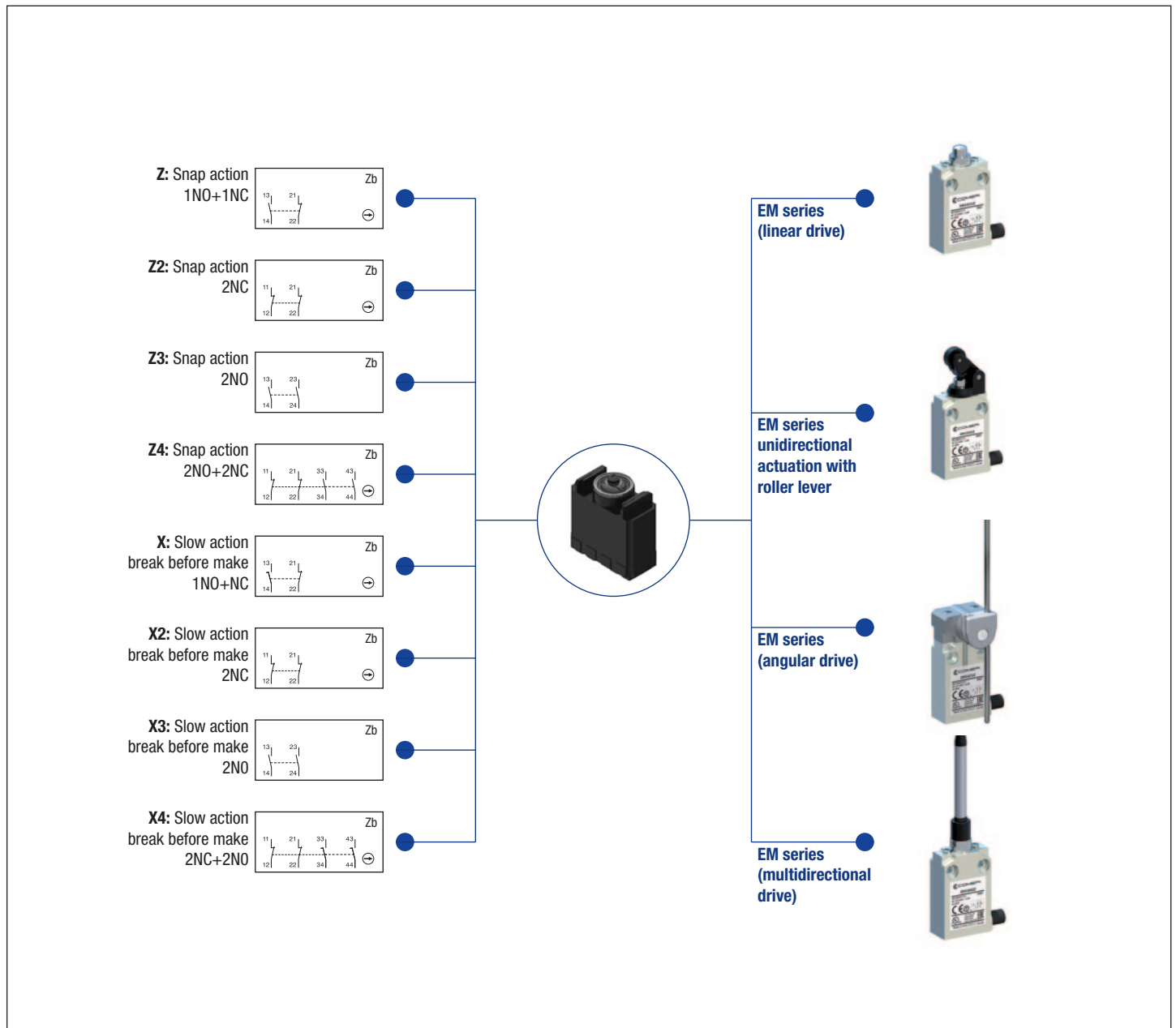

Limit Switches **EM series**

Technical Data

	EM Series	
Standards	IEC 60947-5-1 EN 60947-5-1	
Air temperature near the device		
– during operation	°C	– 25 ... + 70
– for storage	°C	– 40 ... + 70
Mounting positions	All positions are authorised	
Protection against electrical shocks (acc. to IEC 61140)	Class I	
Degree of protection (according to IEC 60529 and EN 60529)	IP 67	
Degree of protection (according to UL50)	Type 4 - 4X - 6 enclosure ("outdoor use - raintight - watertight - corrosion resistant")	
Switching frequency	Cycles/h	3600
Mechanical durability	10 millions of operations	

Electrical data - Electrical connections

Code	EM_U	EM_UP	EM_HF	EM_LW	EM_M	EM_A
Cable type	5xAWG18 0,75mm ² PVC Style 2517	5xAWG18 dynamic 0,75mm ² PVC Style 20668	5xAWG18 dynamic 0,75mm ² PVC Style 20668	5xAWG18 0,75mm ² Silicone cable	–	–
Min. bend radius	57mm	57mm	57mm	57mm	–	–
Rated insulation voltage U _i	400V	300V	300V	300V	250V	250V
Pollution degree	3	3	3	3	3	3
Rated impulse withstand voltage U _{imp}	4kV	4kV	4kV	4kV	2.5kV	2.5kV
Conventional free air thermal current I _{th}	10A	10A	10A	10A	4A	4A
Short circuit current I _{cc}	1kA	1kA	1kA	1kA	1kA	1kA
Short-circuit protection	10A 500V type gG	10A 500V type gG	10A 500V type gG	4A 500V type gG	4A 500V type gG	4A 500V type gG
AC15	24V 120V 240V	10A 6A 3A	10A 6A 3A	10A 6A 3A	4A 4A 3A	4A 4A 3A
DC13	24V 125V 250V	2.8A 0.55A 0.27A	2.8A 0.55A 0.27A	2.8A 0.55A 0.27A	2.8A 0.55A 0.27A	2.8A 0.55A 0.27A
Approvals	cULus EAC CCC UKCA	cULus EAC CCC UKCA	cULus EAC CCC UKCA	cULus EAC CCC UKCA	IMQ cULus EAC CCC UKCA	EAC UKCA

Code	X2/X3	X4	Z2/Z3	Z4
Connection type	5xAWG18 0,75mm ² PVC Style 2517	9xAWG22 0,5mm ² PVC Style 2517	5xAWG18 0,75mm ² PVC Style 2517	9xAWG22 0,5mm ² PVC Style 2517
Min. bend radius	49mm	49mm	49mm	49mm
Rated insulation voltage U _i	250V	250V	250V	250V
Pollution degree	3	3	3	3
Rated impulse withstand voltage U _{imp}	2.5kV	2.5kV	2.5kV	2.5kV
Conventional free air thermal current I _{th}	4A	4A	4A	4A
Short-circuit protection	4A 500V type gG	4A 500V type gG	4A 500V type gG	4A 500V Type gG
AC15	24V 240V	4A 3A	4A 3A	4A 3A
DC13	24V 250V	2A 0.4A	2A 0.4A	2A /
Approvals	cULus EAC CCC UKCA	cULus EAC CCC UKCA	cULus EAC CCC UKCA	cULus EAC CCC UKCA

Limit Switches **EM series**

Wiring Diagram

Serie EM_U / EM_UP / EM_HF

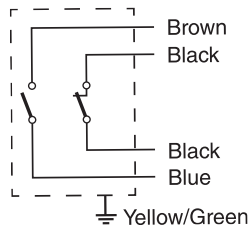

Serie EM_LW

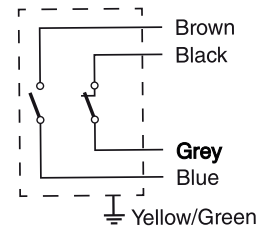

Serie EM_A

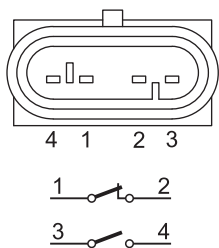

Serie EM_M

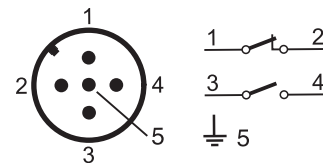

Serie EM_X2 / Z2

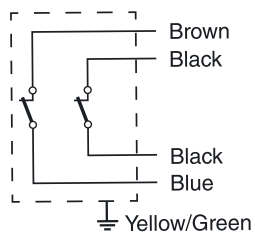

Serie EM_X3 / Z3

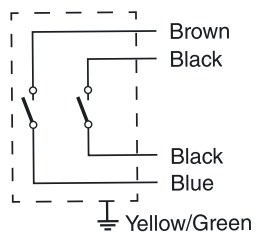

Serie EM_X4 / Z4

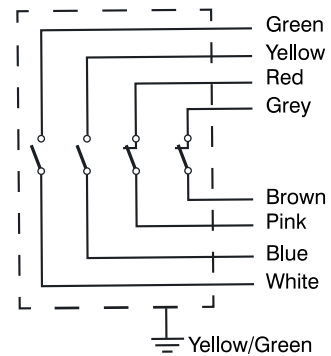

Limit Switches **EM series**

Technical Data



Standard PVC UL cable

All models can be supplied with a standard PVC UL cable.
To order, keep the suffix "U" of the standard
Example: EM1G11ZU

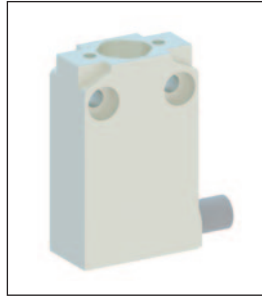

Dynamic PUR cable

greater flexibility characterize these models compared to the UL standard, while maintaining the same features and the same electrical ratings. Moreover, the external sheath, polyurethane made, guarantees more resistance in stern working environments.
To order add the digit "P" at the end of the UL standard part number.
Example: EM1G11ZU ➔ EM1G11ZUP

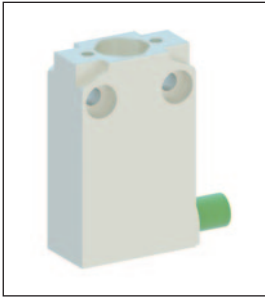

Halogen free PUR cable

The absence of halogens guarantees less fumes and toxic gases released in case of fire. Moreover, the external sheath, polyurethane made, guarantees more resistance in stern working environments.
To order add the digit "HF" at the end of the part number.
Example: EM1G11ZHF

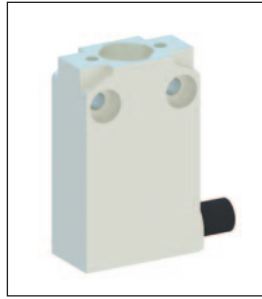

Silicone Cable

Designed to remain flexible even at low temperatures (-40°).
All the models can be supplied with silicone cable.
To order replace the "U" suffix of the standard UL version with suffix "LW".
Example: EM1G11ZU ➔ EM1G11ZLW



AMP connector

All the models can be supplied with AMP connector.
To order replace the "U" suffix of the standard UL version with suffix "A".
Example: EM1G11ZU ➔ EM1G11ZA

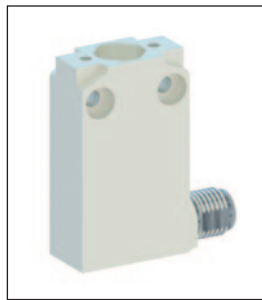

M12 connector

All the models can be supplied with M12 connector.
To order replace the "U" suffix of the standard UL version with suffix "M".
Example: EM1G11ZU ➔ EM1G11ZM

Cable connection orientation



Cable connection orientation

For EM1 Series, standard version is supplied with right electrical connection exit.
Available version with left or central exit: add respectively digit "L" or "C" at the end of the complete part number.
Example: EM1G11ZU ➔ EM1G11ZUL



For EM2 Series, standard version is supplied with central electrical connection exit.

Available version with left or right exit: add respectively digit "L" or "R" at the end of the complete part number.
Example: EM2G11ZU ➔ EM2G11ZUR

Limit Switches **EM series**

Technical Data

Technical data approved by IMQ

Standards		Devices conform with international IEC 60947-5-1 and European EN 60947-5-1 standards
Degree of protection		IP 67
Rated insulation voltage U_i		400 V (degree of pollution 3) (250V for M12 connector)
Rated impulse withstand voltage U_{imp}		4 kV (2.5 kV for M12 connector)
Conventional free air thermal current I_{th}		10 A (4A for M12 connector)
Short-circuit protection - gG (gl) type fuses		10 A (4A for M12 connector)
Rated operational current		
I_e / AC-15	24 V - 50/60 Hz	10 A (except M12 connector)
	400 V - 50/60 Hz	3 A (except M12 connector)
I_e / DC-13	24 V - d.c.	2.8 A
	250 V - d.c.	0.27 A

Technical data approved by UL

Standards		Devices conform with UL 508
Degree of protection:		
EP Series	Type 1 enclosure ("indoor use only")	
Serie Metallo EM	Type 4 - 4X - 6 enclosure ("outdoor use raintight - watertight - corrosion resistant")	
Utilization categories:		
Cable versions	B300 - R300 (C300-R300)	
M12 connector versions	Class-2	

For the complete list of approved products, contact our technical department

IMPLEMENTATION

Operating head orientation

The head can be rotated each 180° (90° for special version with fixing pins).

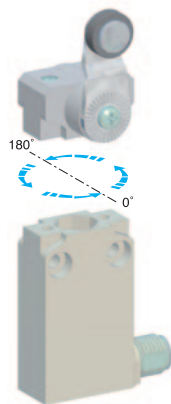

Lever adjustment

The lever of the angular actuators can be adjusted every 10° and round turned in order to obtain the maximum flexibility on the working plan. Recommended tightening torque 0,5 Nm (max 0,8 Nm).

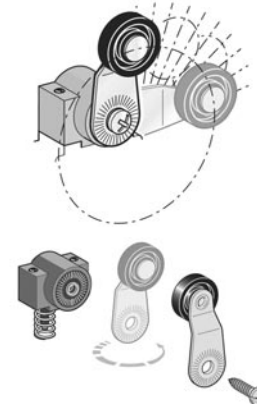

Special Versions



Head installation

Two different solutions are available to fix the head to the body of the switch. The standard solution is made by means of two $\varnothing 3$ screws. On some models it is possible to order the switch with head fixation by means of two pins. This solution will allow a greater resistance to vibrations when needed and it makes it possible for the end user to install the limit switch directly on a panel as shown in the picture on the side.

Please contact our technical department for further details.

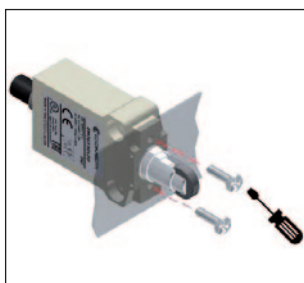

Limit Switches **EM1G series**

Pre-wired - Metal Casing IP67 - 30 mm. width

Electrical connection:

Pre-Wired

Cable: PVC 5 x 0,75 mm²

Length: 1 m.

Pre-wired

See page 92 for all the available connection variants

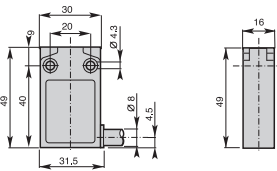

G11 - Plain plunger

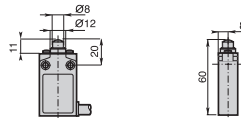

Min. actuating force
Weight

15N (30N ⇄)
175 g

G1 - Roller plunger

G12: metal roller G13: nylon roller

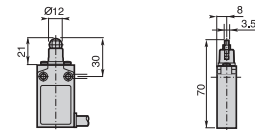

Min. actuating force
Weight

10N (30N ⇄)
180 g

G1 - Cross roller plunger

G14: metal roller G15: nylon roller

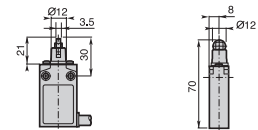

Min. actuating force
Weight

10N (30N ⇄)
180 g

Contact Blocks

Z Snap action contacts (1NO + 1NC)	EM1G11ZU	EM1G12ZU	EM1G13ZU	EM1G14ZU	EM1G15ZU
Z2 Snap action contacts (2NC)	EM1G11Z2U	EM1G12Z2U	EM1G13Z2U	EM1G14Z2U	EM1G15Z2U
Z3 Snap action contacts (2NO)	EM1G11Z3U	EM1G12Z3U	EM1G13Z3U	EM1G14Z3U	EM1G15Z3U
Z4 Snap action contacts (2NC + 2NO)	EM1G11Z4U	EM1G12Z4U	EM1G13Z4U	EM1G14Z4U	EM1G15Z4U
X Non overlapping slow action contacts (1NO + 1NC)	EM1G11XU	EM1G12XU	EM1G13XU	EM1G14XU	EM1G15XU
X2 Slow action contacts (2NC)	EM1G11X2U	EM1G12X2U	EM1G13X2U	EM1G14X2U	EM1G15X2U
X3 Slow action contacts (2NO)	EM1G11X3U	EM1G12X3U	EM1G13X3U	EM1G14X3U	EM1G15X3U
X4 Non overlapping slow action contacts (2NO + 2NC)	EM1G11X4U	EM1G12X4U	EM1G13X4U	EM1G14X4U	EM1G15X4U

G16 - Plain plunger with dust protection cup

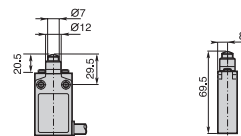

Min. actuating force
Weight

15N (30N ⇄)
180 g

G17 - Metal roller plunger with dust protection cup

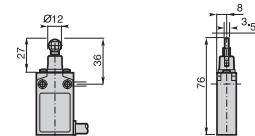

Min. actuating force
Weight

10N (30N ⇄)
190 g

G18 - Bevel plunger

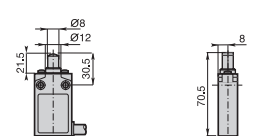

Min. actuating force
Weight

10N (30N ⇄)
185 g

Contact Blocks

Z Snap action contacts (1NO + 1NC)	EM1G16ZU	EM1G17ZU	EM1G18ZU
Z2 Snap action contacts (2NC)	EM1G16Z2U	EM1G17Z2U	EM1G18Z2U
Z3 Snap action contacts (2NO)	EM1G16Z3U	EM1G17Z3U	EM1G18Z3U
Z4 Snap action contacts (2NC + 2NO)	EM1G16Z4U	EM1G17Z4U	EM1G18Z4U
X Non overlapping slow action contacts (1NO + 1NC)	EM1G16XU	EM1G17XU	EM1G18XU
X2 Slow action contacts (2NC)	EM1G16X2U	EM1G17X2U	EM1G18X2U
X3 Slow action contacts (2NO)	EM1G16X3U	EM1G17X3U	EM1G18X3U
X4 Non overlapping slow action contacts (2NO + 2NC)	EM1G16X4U	EM1G17X4U	EM1G18X4U

Operation diagrams: page 127 - All dimensions are in mm

Limit Switches **EM1G series**

Pre-wired - Metal Casing IP67 - 30 mm. width

Electrical connection:

Pre-Wired

Cable: PVC 5 x 0,75 mm²

Length: 1 m.

Pre-wired

See page 92 for all the available connection variants

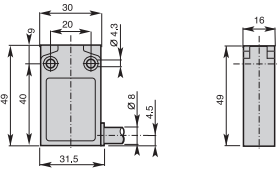

Contact Blocks

Z Snap action contacts (1NO + 1NC)	EM1G21ZU	EM1G22ZU	EM1G23ZU	EM1G24ZU	EM1G25ZU
Z2 Snap action contacts (2NC)	EM1G21Z2U	EM1G22Z2U	EM1G23Z2U	EM1G24Z2U	EM1G25Z2U
Z3 Snap action contacts (2NO)	EM1G21Z3U	EM1G22Z3U	EM1G23Z3U	EM1G24Z3U	EM1G25Z3U
Z4 Snap action contacts (2NC + 2NO)	EM1G21Z4U	EM1G22Z4U	EM1G23Z4U	EM1G24Z4U	EM1G25Z4U
X Non overlapping slow action contacts (1NO + 1NC)	EM1G21XU	EM1G22XU	EM1G23XU	EM1G24XU	EM1G25XU
X2 Slow action contacts (2NC)	EM1G21X2U	EM1G22X2U	EM1G23X2U	EM1G24X2U	EM1G25X2U
X3 Slow action contacts (2NO)	EM1G21X3U	EM1G22X3U	EM1G23X3U	EM1G24X3U	EM1G25X3U
X4 Non overlapping slow action contacts (2NO + 2NC)	EM1G21X4U	EM1G22X4U	EM1G23X4U	EM1G24X4U	EM1G25X4U

G21 - Plain plunger with fixing nuts

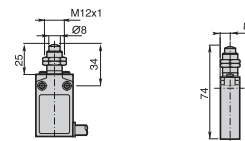

Min. actuating force **10N (30N ⊖)**
Weight **190 g**

G2• - Roller plunger with fixing nuts

G22: metal roller G23: nylon roller

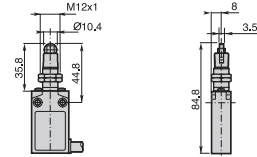

Min. actuating force **10N (30N ⊖)**
Weight **195 g**

G2• - Cross roller plunger with fixing nuts

G24: metal roller G25: nylon roller

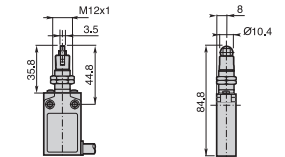

Min. actuating force **10N (30N ⊖)**
Weight **195 g**

G31 - Nylon roller lever

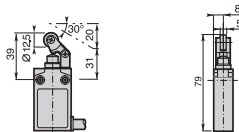

Min. actuating force **7N (24N ⊖)**
Weight **180 g**

G32 - Nylon roller lever

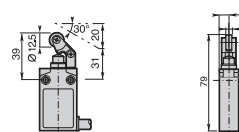

Min. actuating force **7N (24N ⊖)**
Weight **180 g**

G38 - Adjustable nylon roller lever

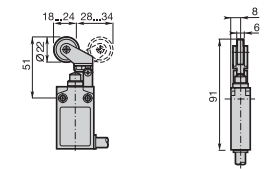

Min. actuating force **7N (24N ⊖)**
Weight **185 g**

Contact Blocks

Z Snap action contacts (1NO + 1NC)	EM1G31ZU	EM1G32ZU	EM1G38ZU
Z2 Snap action contacts (2NC)	EM1G31Z2U	EM1G32Z2U	EM1G38Z2U
Z3 Snap action contacts (2NO)	EM1G31Z3U	EM1G32Z3U	EM1G38Z3U
Z4 Snap action contacts (2NC + 2NO)	EM1G31Z4U	EM1G32Z4U	EM1G38Z4U
X Non overlapping slow action contacts (1NO + 1NC)	EM1G31XU	EM1G32XU	EM1G38XU
X2 Slow action contacts (2NC)	EM1G31X2U	EM1G32X2U	EM1G38X2U
X3 Slow action contacts (2NO)	EM1G31X3U	EM1G32X3U	EM1G38X3U
X4 Non overlapping slow action contacts (2NO + 2NC)	EM1G31X4U	EM1G32X4U	EM1G38X4U

Operation diagrams: page 127 - All dimensions are in mm

Limit Switches **EM1G series**

Pre-wired - Metal Casing IP67 - 30 mm. width

Electrical connection:

Pre-Wired

Cable: PVC 5 x 0,75 mm²

Length: 1 m.

Pre-wired

See page 92 for all the available connection variants

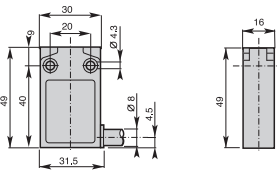

G4• - Ø14 Roller lever

G41: nylon roller G42: metal roller

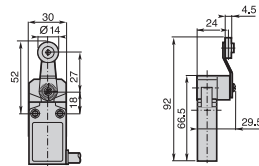

Min. actuating torque **0,08Nm (0,28Nm ⊖)**
Weight **225 g**

G43 - Ø14 Roller lever with ball bearing

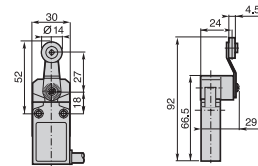

Min. actuating torque **0,08Nm (0,28Nm ⊖)**
Weight **225 g**

G4• - Ø18 Roller lever

G45: nylon roller G46: metal roller

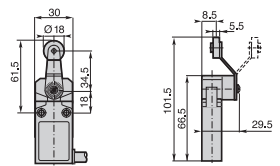

Min. actuating torque **0,08Nm (0,28Nm ⊖)**
Weight **230 g**

Contact Blocks

Z Snap action contacts (1NO + 1NC)	EM1G41ZU	EM1G42ZU	EM1G43ZU	EM1G45ZU	EM1G46ZU
Z2 Snap action contacts (2NC)	EM1G41Z2U	EM1G42Z2U	EM1G43Z2U	EM1G45Z2U	EM1G46Z2U
Z3 Snap action contacts (2NO)	EM1G41Z3U	EM1G42Z3U	EM1G43Z3U	EM1G45Z3U	EM1G46Z3U
Z4 Snap action contacts (2NC + 2NO)	EM1G41Z4U	EM1G42Z4U	EM1G43Z4U	EM1G45Z4U	EM1G46Z4U
X Non overlapping slow action contacts (1NO + 1NC)	EM1G41XU	EM1G42XU	EM1G43XU	EM1G45XU	EM1G46XU
X2 Slow action contacts (2NC)	EM1G41X2U	EM1G42X2U	EM1G43X2U	EM1G45X2U	EM1G46X2U
X3 Slow action contacts (2NO)	EM1G41X3U	EM1G42X3U	EM1G43X3U	EM1G45X3U	EM1G46X3U
X4 Non overlapping slow action contacts (2NO + 2NC)	EM1G41X4U	EM1G42X4U	EM1G43X4U	EM1G45X4U	EM1G46X4U

G5• - Adjustable lever with Ø18 roller

G51: nylon roller G53: metal roller

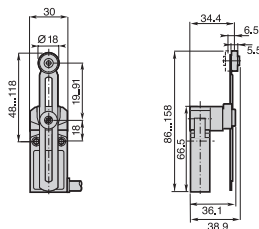
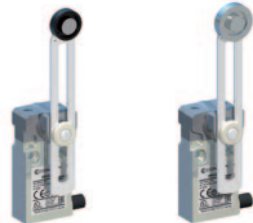

Min. actuating torque **0,08Nm (0,28Nm ⊖)**
Weight **240 g**

G5100 - Adjustable toothed lever (step 2 mm) with Ø18 nylon roller

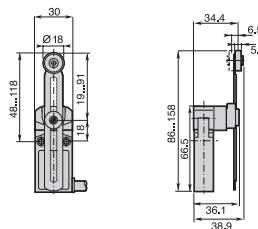

Min. actuating torque **0,08Nm (0,28Nm ⊖)**
Weight **240 g**

G61 - Nylon actuator with stainless steel spring

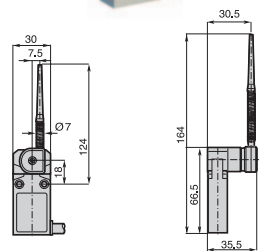

Min. actuating torque **0,08Nm**
Weight **240 g**

Contact Blocks

Z Snap action contacts (1NO + 1NC)	EM1G51ZU	EM1G52ZU	EM1G5100ZU	EM1G61ZU
Z2 Snap action contacts (2NC)	EM1G51Z2U	EM1G52Z2U	EM1G5100Z2U	EM1G61Z2U
Z3 Snap action contacts (2NO)	EM1G51Z3U	EM1G52Z3U	EM1G5100Z3U	EM1G61Z3U
Z4 Snap action contacts (2NC + 2NO)	EM1G51Z4U	EM1G52Z4U	EM1G5100Z4U	EM1G61Z4U
X Non overlapping slow action contacts (1NO + 1NC)	EM1G51XU	EM1G52XU	EM1G5100XU	EM1G61XU
X2 Slow action contacts (2NC)	EM1G51X2U	EM1G52X2U	EM1G5100X2U	EM1G61X2U
X3 Slow action contacts (2NO)	EM1G51X3U	EM1G52X3U	EM1G5100X3U	EM1G61X3U
X4 Non overlapping slow action contacts (2NO + 2NC)	EM1G51X4U	EM1G52X4U	EM1G5100X4U	EM1G61X4U

Operation diagrams: page 127 - All dimensions are in mm

Limit Switches **EM1G series**

Pre-wired - Metal Casing IP67 - 30 mm. width

Electrical connection:

Pre-Wired

Cable: PVC 5 x 0,75 mm²

Length: 1 m.

Pre-wired

See page 92 for all the available connection variants

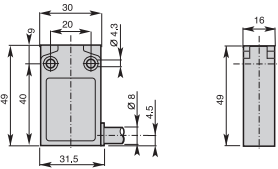

G7• - Adjustable Ø3 rod lever

G71: stainless steel rod G72: fiberglass rod

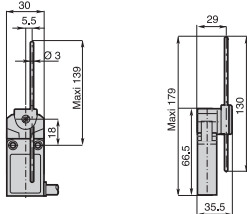
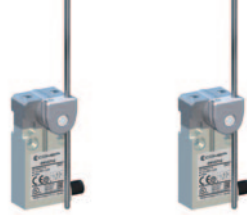

Min. actuating torque **0,08Nm (0,28Nm ⊖)**
Weight **235 g**

G7• - Adjustable Ø6 rod lever

G73: nylon rod G74: fiberglass rod

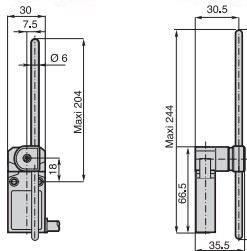

Min. actuating torque **0,08Nm (0,28Nm ⊖)**
Weight **250 g**

G75 - Adjustable 3x3 square steel rod lever

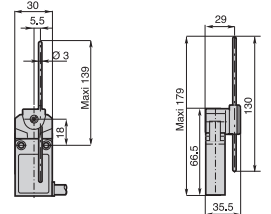

Min. actuating torque **0,08Nm (0,28Nm ⊖)**
Weight **235 g**

Contact Blocks

Z Snap action contacts (1NO + 1NC)	EM1G71ZU	EM1G72ZU	EM1G73ZU	EM1G74ZU	EM1G75ZU
Z2 Snap action contacts (2NC)	EM1G71Z2U	EM1G72Z2U	EM1G73Z2U	EM1G74Z2U	EM1G75Z2U
Z3 Snap action contacts (2NO)	EM1G71Z3U	EM1G72Z3U	EM1G73Z3U	EM1G74Z3U	EM1G75Z3U
Z4 Snap action contacts (2NC + 2NO)	EM1G71Z4U	EM1G72Z4U	EM1G73Z4U	EM1G74Z4U	EM1G75Z4U
X Non overlapping slow action contacts (1NO + 1NC)	EM1G71XU	EM1G72XU	EM1G73XU	EM1G74XU	EM1G75XU
X2 Slow action contacts (2NC)	EM1G71X2U	EM1G72X2U	EM1G73X2U	EM1G74X2U	EM1G75X2U
X3 Slow action contacts (2NO)	EM1G71X3U	EM1G72X3U	EM1G73X3U	EM1G74X3U	EM1G75X3U
X4 Non overlapping slow action contacts (2NO + 2NC)	EM1G71X4U	EM1G72X4U	EM1G73X4U	EM1G74X4U	EM1G75X4U

G92 - Multidirectional nylon actuator with stainless steel spring

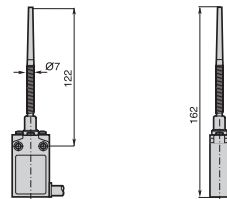

Min. actuating torque **0,10Nm**
Weight **245 g**

G93 - Multidirectional actuator with stainless steel spring

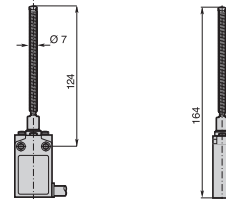

Min. actuating torque **0,10Nm**
Weight **250 g**

Contact Blocks

Z Snap action contacts (1NO + 1NC)	EM1G92ZU	EM1G93ZU
Z2 Snap action contacts (2NC)	EM1G92Z2U	EM1G93Z2U
Z3 Snap action contacts (2NO)	EM1G92Z3U	EM1G93Z3U
Z4 Snap action contacts (2NC + 2NO)	EM1G92Z4U	EM1G93Z4U
X Non overlapping slow action contacts (1NO + 1NC)		
X2 Slow action contacts (2NC)		
X3 Slow action contacts (2NO)		
X4 Non overlapping slow action contacts (2NO + 2NC)		

Operation diagrams: page 127 - All dimensions are in mm

Limit Switches **EM2G series**

Pre-wired - Metal Casing IP67 - 35 mm. width

Electrical connection:

Pre-Wired

Cable: PVC 5 x 0,75 mm²

Length: 1 m.

Pre-wired

See page 92 for all the available connection variants

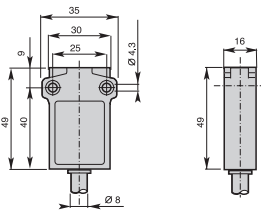

Contact Blocks

	G11 - Plain plunger	G1 - Roller plunger		G1 - Cross roller plunger	
		G12: metal roller	G13: nylon roller	G14: metal roller	G15: nylon roller
Z Snap action contacts (1NO + 1NC)	EM2G11ZU	EM2G12ZU	EM2G13ZU	EM2G14ZU	EM2G15ZU
Z2 Snap action contacts (2NC)	EM2G11Z2U	EM2G12Z2U	EM2G13Z2U	EM2G14Z2U	EM2G15Z2U
Z3 Snap action contacts (2NO)	EM2G11Z3U	EM2G12Z3U	EM2G13Z3U	EM2G14Z3U	EM2G15Z3U
Z4 Snap action contacts (2NC + 2NO)	EM2G11Z4U	EM2G12Z4U	EM2G13Z4U	EM2G14Z4U	EM2G15Z4U
X Non overlapping slow action contacts (1NO + 1NC)	EM2G11XU	EM2G12XU	EM2G13XU	EM2G14XU	EM2G15XU
X2 Slow action contacts (2NC)	EM2G11X2U	EM2G12X2U	EM2G13X2U	EM2G14X2U	EM2G15X2U
X3 Slow action contacts (2NO)	EM2G11X3U	EM2G12X3U	EM2G13X3U	EM2G14X3U	EM2G15X3U
X4 Non overlapping slow action contacts (2NO + 2NC)	EM2G11X4U	EM2G12X4U	EM2G13X4U	EM2G14X4U	EM2G15X4U

G11 - Plain plunger

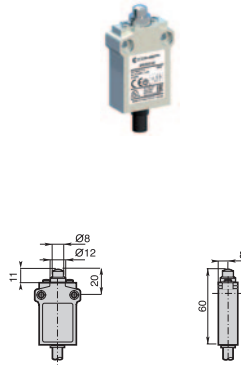

Min. actuating force
Weight **15N (30N ⇄)**
180 g

G1 - Roller plunger

G12: metal roller G13: nylon roller

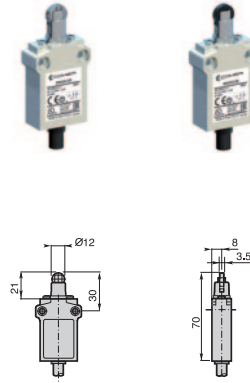

Min. actuating force
Weight **10N (30N ⇄)**
185 g

G1 - Cross roller plunger

G14: metal roller G15: nylon roller

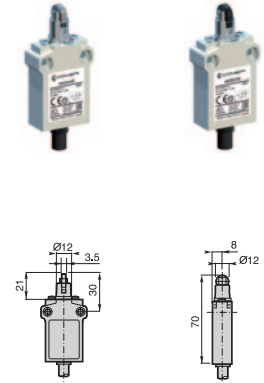

Min. actuating force
Weight **10N (30N ⇄)**
185 g

G16 - Plain plunger with dust protection cup

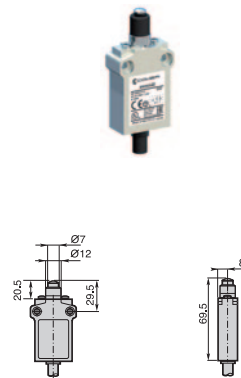

Min. actuating force
Weight **15N (30N ⇄)**
185 g

G17 - Metal roller plunger with dust protection cup

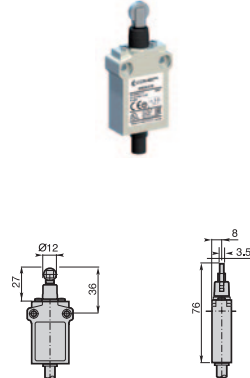

Min. actuating force
Weight **10N (30N ⇄)**
195 g

G18 - Bevel plunger

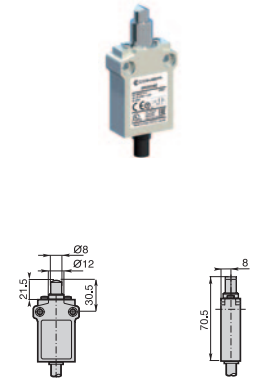

Min. actuating force
Weight **10N (30N ⇄)**
190 g

Contact Blocks

	G16 - Plain plunger with dust protection cup	G17 - Metal roller plunger with dust protection cup	G18 - Bevel plunger
Z Snap action contacts (1NO + 1NC)	EM2G16ZU	EM2G17ZU	EM2G18ZU
Z2 Snap action contacts (2NC)	EM2G16Z2U	EM2G17Z2U	EM2G18Z2U
Z3 Snap action contacts (2NO)	EM2G16Z3U	EM2G17Z3U	EM2G18Z3U
Z4 Snap action contacts (2NC + 2NO)	EM2G16Z4U	EM2G17Z4U	EM2G18Z4U
X Non overlapping slow action contacts (1NO + 1NC)	EM2G16XU	EM2G17XU	EM2G18XU
X2 Slow action contacts (2NC)	EM2G16X2U	EM2G17X2U	EM2G18X2U
X3 Slow action contacts (2NO)	EM2G16X3U	EM2G17X3U	EM2G18X3U
X4 Non overlapping slow action contacts (2NO + 2NC)	EM2G16X4U	EM2G17X4U	EM2G18X4U

Operation diagrams: page 127 - All dimensions are in mm

Limit Switches **EM2G series**

Pre-wired - Metal Casing IP67 - 35 mm. width

Electrical connection:

Pre-Wired

Cable: PVC 5 x 0,75 mm²

Length: 1 m.

Pre-wired

See page 92 for all the available connection variants

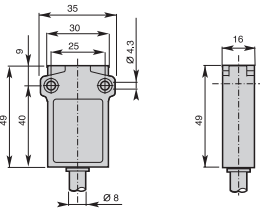

Contact Blocks

Z Snap action contacts (1NO + 1NC)	EM2G21ZU	EM2G22ZU	EM2G23ZU	EM2G24ZU	EM2G25ZU
Z2 Snap action contacts (2NC)	EM2G21Z2U	EM2G22Z2U	EM2G23Z2U	EM2G24Z2U	EM2G25Z2U
Z3 Snap action contacts (2NO)	EM2G21Z3U	EM2G22Z3U	EM2G23Z3U	EM2G24Z3U	EM2G25Z3U
Z4 Snap action contacts (2NC + 2NO)	EM2G21Z4U	EM2G22Z4U	EM2G23Z4U	EM2G24Z4U	EM2G25Z4U
X Non overlapping slow action contacts (1NO + 1NC)	EM2G21XU	EM2G22XU	EM2G23XU	EM2G24XU	EM2G25XU
X2 Slow action contacts (2NC)	EM2G21X2U	EM2G22X2U	EM2G23X2U	EM2G24X2U	EM2G25X2U
X3 Slow action contacts (2NO)	EM2G21X3U	EM2G22X3U	EM2G23X3U	EM2G24X3U	EM2G25X3U
X4 Non overlapping slow action contacts (2NO + 2NC)	EM2G21X4U	EM2G22X4U	EM2G23X4U	EM2G24X4U	EM2G25X4U

G21 - Roller plunger with fixing nuts

Min. actuating force **10N (30N ⊖)**
Weight **195 g**

G2• - Roller plunger with fixing nuts

G22: metal roller G23: nylon roller

Min. actuating force **10N (30N ⊖)**
Weight **200 g**

G2• - Cross roller plunger with fixing nuts

G24: metal roller G25: nylon roller

Min. actuating force **10N (30N ⊖)**
Weight **200 g**

G31 - Nylon roller lever

Min. actuating force **7N (24N ⊖)**
Weight **185 g**

G32 - Nylon roller lever

Min. actuating force **7N (24N ⊖)**
Weight **185 g**

G38 - Adjustable nylon roller lever

Min. actuating force **7N (24N ⊖)**
Weight **190 g**

Contact Blocks

Z Snap action contacts (1NO + 1NC)	EM2G31ZU	EM2G32ZU	EM2G38ZU
Z2 Snap action contacts (2NC)	EM2G31Z2U	EM2G32Z2U	EM2G38Z2U
Z3 Snap action contacts (2NO)	EM2G31Z3U	EM2G32Z3U	EM2G38Z3U
Z4 Snap action contacts (2NC + 2NO)	EM2G31Z4U	EM2G32Z4U	EM2G38Z4U
X Non overlapping slow action contacts (1NO + 1NC)	EM2G31XU	EM2G32XU	EM2G38XU
X2 Slow action contacts (2NC)	EM2G31X2U	EM2G32X2U	EM2G38X2U
X3 Slow action contacts (2NO)	EM2G31X3U	EM2G32X3U	EM2G38X3U
X4 Non overlapping slow action contacts (2NO + 2NC)	EM2G31X4U	EM2G32X4U	EM2G38X4U

Operation diagrams: page 127 - All dimensions are in mm

Limit Switches **EM2G series**

Pre-wired - Metal Casing IP67 - 35 mm. width

Electrical connection:

Pre-Wired

Cable: PVC 5 x 0,75 mm²

Length: 1 m.

Pre-wired

See page 92 for all the available connection variants

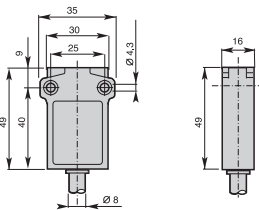

G4• - Ø14 roller lever

G41: nylon roller G42: metal roller

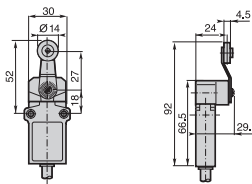

Min. actuating torque **0,08Nm (0,28Nm ⊖)**
Weight **230 g**

G43 - Ø14 roller lever with ball bearing

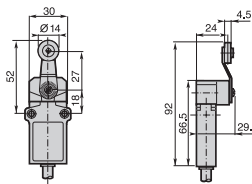

Min. actuating torque **0,08Nm (0,28Nm ⊖)**
Weight **230 g**

G4• - Ø18 metal lever

G45: nylon roller G46: nylon roller

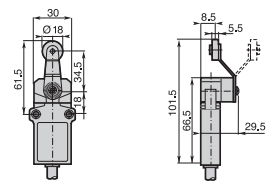

Min. actuating torque **0,08Nm (0,28Nm ⊖)**
Weight **235 g**

Contact Blocks

Z Snap action contacts (1NO + 1NC)	EM2G41ZU	EM2G42ZU	EM2G43ZU	EM2G45ZU	EM2G46ZU
Z2 Snap action contacts (2NC)	EM2G41Z2U	EM2G42Z2U	EM2G43Z2U	EM2G45Z2U	EM2G46Z2U
Z3 Snap action contacts (2NO)	EM2G41Z3U	EM2G42Z3U	EM2G43Z3U	EM2G45Z3U	EM2G46Z3U
Z4 Snap action contacts (2NC + 2NO)	EM2G41Z4U	EM2G42Z4U	EM2G43Z4U	EM2G45Z4U	EM2G46Z4U
X Non overlapping slow action contacts (1NO + 1NC)	EM2G41XU	EM2G42XU	EM2G43XU	EM2G45XU	EM2G46XU
X2 Slow action contacts (2NC)	EM2G41X2U	EM2G42X2U	EM2G43X2U	EM2G45X2U	EM2G46X2U
X3 Slow action contacts (2NO)	EM2G41X3U	EM2G42X3U	EM2G43X3U	EM2G45X3U	EM2G46X3U
X4 Non overlapping slow action contacts (2NO + 2NC)	EM2G41X4U	EM2G42X4U	EM2G43X4U	EM2G45X4U	EM2G46X4U

G5• - Adjustable lever with Ø18 roller

G51: nylon roller G53: metal roller

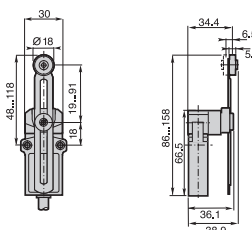

Min. actuating torque **0,08Nm (0,28Nm ⊖)**
Weight **245 g**

G5100 - Adjustable toothed lever (stem 2 mm) with Ø18 nylon roller

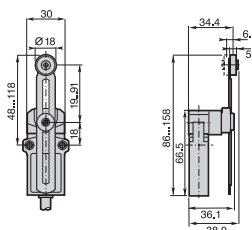

Min. actuating torque **0,08Nm (0,28Nm ⊖)**
Weight **245 g**

G61 - Nylon actuator with stainless steel spring

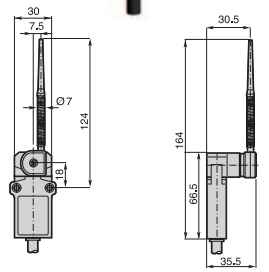

Min. actuating torque **0,08Nm**
Weight **245 g**

Contact Blocks

Z Snap action contacts (1NO + 1NC)	EM2G51ZU	EM2G53ZU	EM2G5100ZU	EM2G61ZU
Z2 Snap action contacts (2NC)	EM2G51Z2U	EM2G53Z2U	EM2G5100Z2U	EM2G61Z2U
Z3 Snap action contacts (2NO)	EM2G51Z3U	EM2G53Z3U	EM2G5100Z3U	EM2G61Z3U
Z4 Snap action contacts (2NC + 2NO)	EM2G51Z4U	EM2G53Z4U	EM2G5100Z4U	EM2G61Z4U
X Non overlapping slow action contacts (1NO + 1NC)	EM2G51XU	EM2G53XU	EM2G5100XU	EM2G61XU
X2 Slow action contacts (2NC)	EM2G51X2U	EM2G53X2U	EM2G5100X2U	EM2G61X2U
X3 Slow action contacts (2NO)	EM2G51X3U	EM2G53X3U	EM2G5100X3U	EM2G61X3U
X4 Non overlapping slow action contacts (2NO + 2NC)	EM2G51X4U	EM2G53X4U	EM2G5100X4U	EM2G61X4U

Operation diagrams: page 127 - All dimensions are in mm

Limit Switches **EM2G series**

Pre-wired - Metal Casing IP67 - 35 mm. width

Electrical connection:

Pre-Wired

Cable: PVC 5 x 0,75 mm²

Length: 1 m.

Pre-wired

See page 92 for all the available connection variants

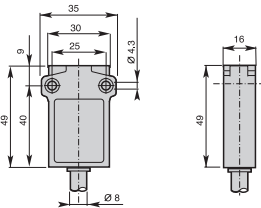

Contact Blocks

Z Snap action contacts (1NO + 1NC)	EM2G71ZU	EM2G72ZU	EM2G73ZU	EM2G74ZU	EM2G75ZU
Z2 Snap action contacts (2NC)	EM2G71Z2U	EM2G72Z2U	EM2G73Z2U	EM2G74Z2U	EM2G75Z2U
Z3 Snap action contacts (2NO)	EM2G71Z3U	EM2G72Z3U	EM2G73Z3U	EM2G74Z3U	EM2G75Z3U
Z4 Snap action contacts (2NC + 2NO)	EM2G71Z4U	EM2G72Z4U	EM2G73Z4U	EM2G74Z4U	EM2G75Z4U
X Non overlapping slow action contacts (1NO + 1NC)	EM2G71XU	EM2G72XU	EM2G73XU	EM2G74XU	EM2G75XU
X2 Slow action contacts (2NC)	EM2G71X2U	EM2G72X2U	EM2G73X2U	EM2G74X2U	EM2G75X2U
X3 Slow action contacts (2NO)	EM2G71X3U	EM2G72X3U	EM2G73X3U	EM2G74X3U	EM2G75X3U
X4 Non overlapping slow action contacts (2NO + 2NC)	EM2G71X4U	EM2G72X4U	EM2G73X4U	EM2G74X4U	EM2G75X4U

G7• - Adjustable Ø3 rod lever

G71: Stainless steel rod G72: fiberglass rod

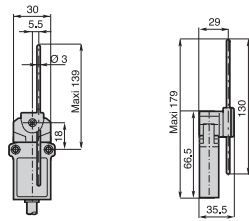

Min. actuating torque **0,08Nm (0,28Nm ⊖)**
Weight **240 g**

G7• - Adjustable Ø6 rod lever

G73: nylon rod G74: fiberglass rod

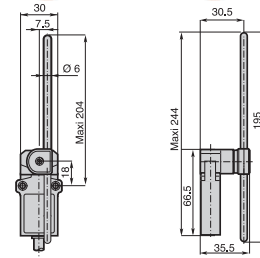

Min. actuating torque **0,08Nm (0,28Nm ⊖)**
Weight **255 g**

G75 - Adjustable 3x3 square steel rod lever

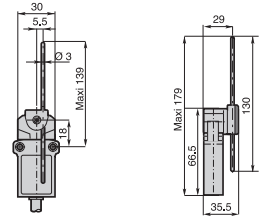

Min. actuating torque **0,08Nm (0,28Nm ⊖)**
Weight **240 g**

G92 - Multidirectional nylon actuator with stainless steel spring

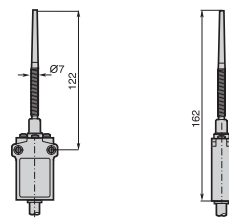

Min. actuating torque **0,10Nm**
Weight **250 g**

G93 - Multidirectional actuator with stainless steel spring

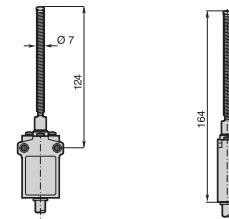

Min. actuating torque **0,10Nm**
Weight **255 g**

Contact Blocks

Z Snap action contacts (1NO + 1NC)	EM2G92ZU	EM2G93ZU
Z2 Snap action contacts (2NC)	EM2G92Z2U	EM2G93Z2U
Z3 Snap action contacts (2NO)	EM2G92Z3U	EM2G93Z3U
Z4 Snap action contacts (2NC + 2NO)	EM2G92Z4U	EM2G93Z4U
X Non overlapping slow action contacts (1NO + 1NC)		
X2 Slow action contacts (2NC)		
X3 Slow action contacts (2NO)		
X4 Non overlapping slow action contacts (2NO + 2NC)		