

Control valve(3/2 way, 5/3 way)

CM3 Series



Specification

Model	CM3□-05	CM3□-06	CM3□-08
Operating	External control		
Fluid	Air (to be filtered by 40 μm filter element)		
Pressure range	0~1.0MPa(0~10bar)(0~145psi)		
Proof pressure	1.5MPa(15bar)(215psi)		
Temperature	-20~70°C		
Valve type [Note1]	3 port 2 position		
Orifice size	2.0mm ²	2.5mm ²	15.0mm ²
Cv	0.11	0.14	0.84
Port size [Note2]	M5×0.8	1/8"	1/4"
Material of body	Aluminum alloy		

[Note1] HD series are 5/3 way.

[Note2] G thread is available.

Symbol

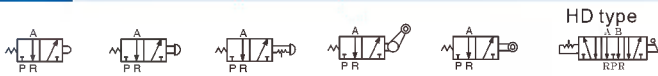

Product feature

1. The external force required by changing the direction of the series of CM3B, CM3V, CM3L and CM3R is provided by external mechanism, which can be used for position test or limit switch.
2. The series of CM3PF, CM3PM, CM3PMS, CM3PMX, CM3PL, CM3PP, CM3HS, CM3HD and CM3Y are operated manually, owning control joints with several structure forms and suitable for application under different conditions.
3. Shut-off structure has good lightness and is sensitive in direction changing and lubricant is not necessary.
4. Multi-mounting makes it convenient to install and apply.
5. The control joints of series of CM3L, CM3V, CM3R and CM3Y are made of metal which has long service life and more reliable and steady performance.
6. CM3PMS, CM3PMX Series have metallic guard, it can protect the push cup, to avoid misact due to outside force touching the push cup. So they can be used more reliably.

Ordering code

CM3 PP 06 B G



① Valve's type	② Model	③ Port size	④ Button color	⑤ Thread type	
CM3: CM type 3/2 5/3 way	B: Basic type	05: M5 06: 1/8" 08: 1/4"	No this code	M5	
	R: Roller type			1/8" 1/4"	
	L: Roller with free return type			No this code	
	V: Vertical type				G: G
	Y: Lever typer				
	PL: Latching type				
	PP: Protruding type				
	PF: Flat type		R: Red G: Green B: Black Y: Yellow		
	PM: Mushroom type				
	PMS: Mushroom type(with guard)				
PMX: Big mushroom type(with guard)					
HS: Selector type					
HD: Double-selector type					

Flow chart

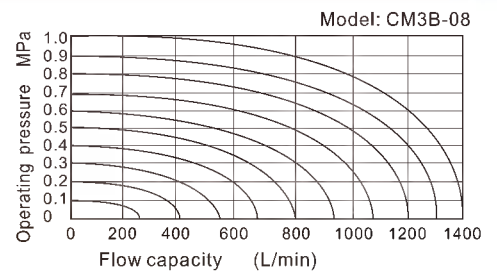
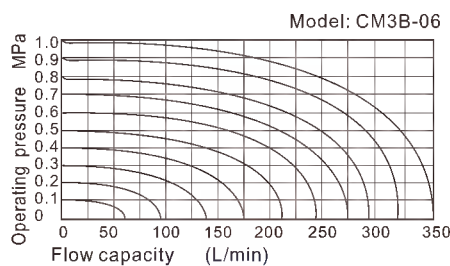
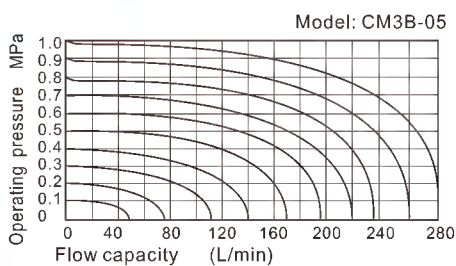

Control valve(3/2 way, 5/3 way)

CM3 Series

Inner structure

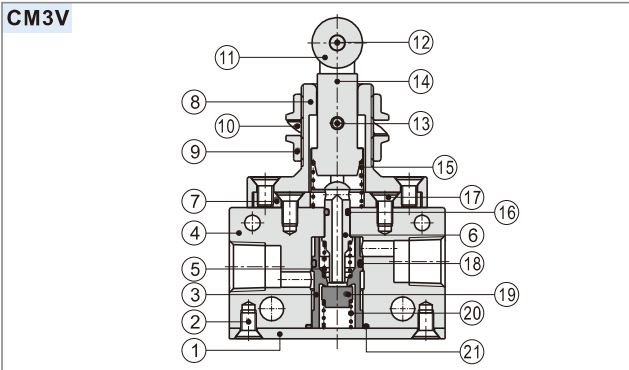

No.	Item	No.	Item	No.	Item
1	Fixing plate	8	Connecting holder	15	Spring
2	Screw	9	Clamping nut	16	O-ring
3	Spacer	10	Spring gasket	17	Screw
4	Body	11	Roller	18	O-ring
5	Spring	12	Shaft	19	Bottom cover gasket
6	Spool	13	Lock pin	20	Spring
7	Connerting gasket	14	Roller bracket	21	O-ring

Installation and operation

1. Mounting way: by body, by panel I, by panel II, latching type, mushroom type. Please refer to the following picture:

Fixation way of body	Fixation way of panel □	Fixation way of panel □	Big mushroom type(With guard)	Mushroom type(With guard)
<p>Fixed plate</p>	<p>Fixed plate Thickness ≤ 6 Fix hole Φ30.5</p>	<p>Fixed plate Thickness ≤ 6 Fix hole Φ14.5</p>	<p>Push cap Guard Fixed plate Thickness ≤ 6 Fix hole Φ30.5</p>	<p>Push cap Guard Fixed plate Thickness ≤ 6 Fix hole Φ30.5</p>
<p>Latching type</p> <p>Fixed plate Thickness ≤ 6 Fix hole Φ30.5</p> <p>Disassembly: Remove the screw, then to draw the button. Assembly: Install the button, then to tighten the screw.</p>	<p>Mushroom type</p> <p>Fixed plate Thickness ≤ 6 Fix hole Φ30.5</p> <p>The button can be drew upward, or be pressed downward.</p>	<p>Disassembly: Remove the push cap, then remove the guard. Assembly: Install the guard, then to tighten the push cap.</p>	<p>Disassembly: Untighten the guard first, then remove the push cap with the guard. Assembly: Install the guard, then to tighten the push cap.</p>	

2. The control set is made of engineering plastic which only allows manual operation and switching valves through metal impact is forbidden.

3. The series of CM3B, CM3L, CM3V, CM3R, CM3PM, CM3PMS, CM3PMX, CM3PF, CM3PP get the function of automatic restoration. The hand valves of CM3Y, CM3HS, CM3HD, CM3PL are in type of manual restoration. CM3PL will be restored by turning the revolve button after being pressed into orientation.

4. Pay attention to the reversing stroke. The reversing stroke can not surpass its stroke stipulated in stroke control table when the direction-change of the valve is forced by any external forces, otherwise it will cause the damage of the valve.

Model	Spool stroke	Button(Roller\Handle) stroke	Model	Spool stroke	Button(Roller\Handle) stroke
CM3B05(06)	1.5~3.0	-	CM3B08	2.4~4.0	-
CM3R05(06)	1.5~2.5	3.0~4.8	CM3R08	2.4~3.2	6.8~9.0
CM3L05(06)	1.5~2.3	3.0~4.8	CM3L08	2.4~3.2	7.2~9.7
CM3V05(06)	1.5~3.0	2.7~4.2	CM3V08	2.4~4.0	2.6~4.2
CM3Y05(06)	1.5~2.5	3.0~4.8	CM3Y08	2.4~3.2	6.8~9.0
CM3PL05(06)	1.5~2.5	4.0~5.0	CM3PL08	2.4~3.5	4.0~5.0
CM3PP05(06)	1.5~3.0	4.0~5.5	CM3PP08	2.4~4.0	4.0~5.5
CM3PF05(06)	1.5~3.0	4.0~5.5	CM3PF08	2.4~4.0	4.0~5.5
CM3HS05(06)	1.5~3.0	4.0~5.5	CM3HS08	2.4~4.0	4.0~5.5
CM3HD05(06)	1.5~3.0	4.0~5.5	CM3HD08	2.4~4.0	4.0~5.5
CM3PM05(06)	1.5~3.0	4.0~5.5	CM3PM08	2.4~4.0	4.0~5.5
CM3PMS05(06)	1.5~3.0	4.0~5.5	CM3PMX08	2.4~4.0	4.0~5.5
CM3PMX05(06)	1.5~3.0	4.0~5.5	CM3PMX08	2.4~4.0	4.0~5.5

5. The CM3L can only switch the valve in single direction(impact from left to right). The impact from the other direction (from right to left) is invalid .

6. Control joint combination can be ordered individually. Please refer to external specification.

Control valve(3/2 way, 5/3 way)

CM3 Series

Dimension (Basic type)

CM3B05

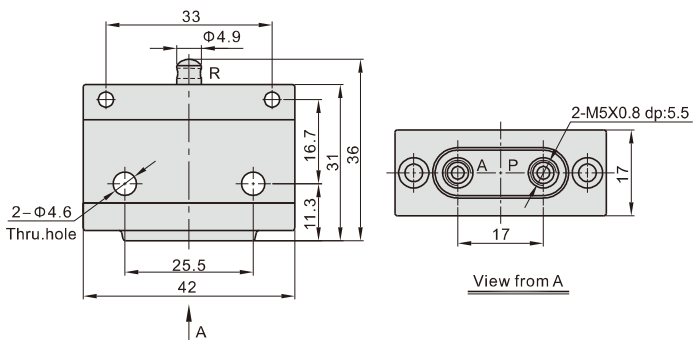

CM3B06

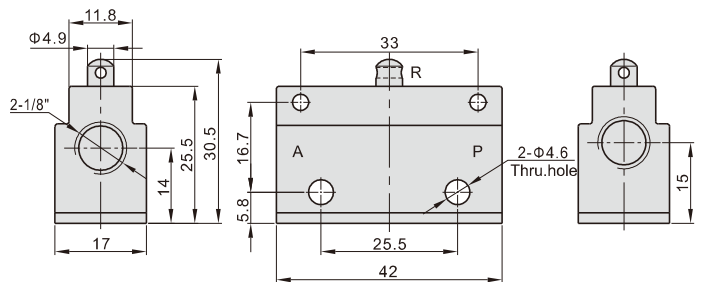

CM3B08

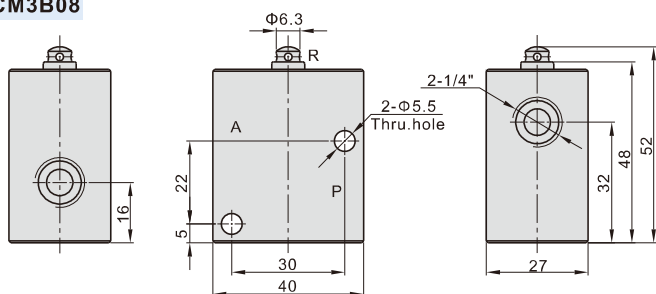

Control set dimension

Roller type(R)

CM3R06-P1

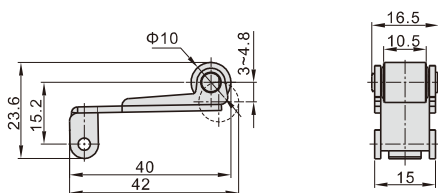

CM3R08-P1

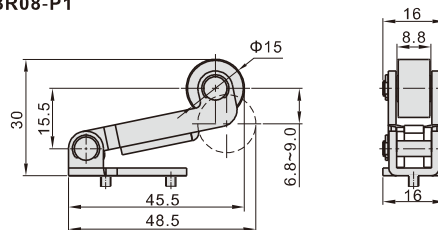

Note: CM3R06 control joint, which used in CM3R05 and CM3R06, can not be ordered individually. It should be matched with basic type.

Model		Roller type(R)
How to order	Ordering code	CM3R08-P1
	Type	CM3R08 roller type control set
Applicable products		CM3R08

Roller with free return type(L)

CM3L06-P1

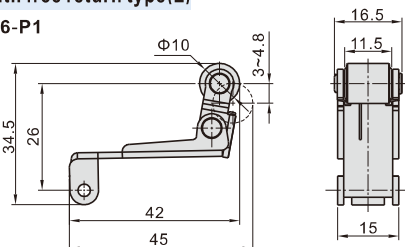

CM3L08-P1

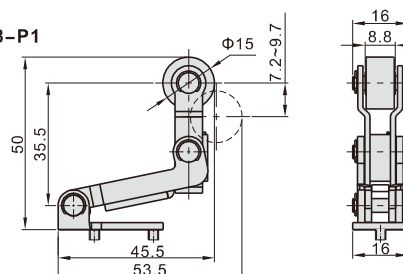

Note: CM3L06 control joint, which used in CM3L05 and CM3L06, can not be ordered individually. It should be matched with basic type.

Model		Roller with free return type(L)
How to order	Ordering code	CM3L08-P1
	Type	CM3L08Roller with free return type control set
Applicable products		CM3L08

Control valve(3/2 way, 5/3 way)

CM3 Series

Lever type(Y)

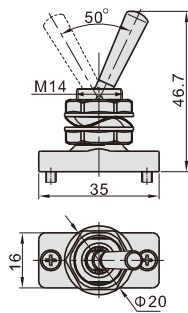

Model		Lever type(Y)
How to order	Ordering code	CM3Y06-P1
	Type	CM3Y lever type control set
Applicable products		CM3Y05 CM3Y06 CM3Y08

Vertical type(V)

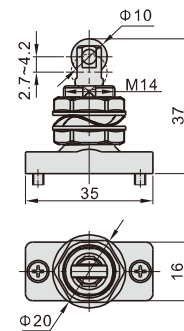

Model		Vertical type (V)
How to order	Ordering code	CM3V06-P1
	Type	CM3V vertical type control set
Applicable products		CM3V05 CM3V06 CM3V08

Mushroom type(PM)

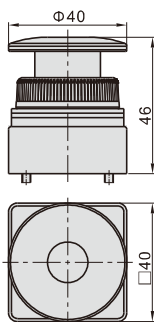

Model		Mushroom type (PM)
How to order	Ordering code	CM3PM06-P1
	Type	CM3PM mushroom type control set(green)
	Ordering code	CM3PM06-P2
	Type	CM3PM mushroom type control set(red)
	Ordering code	CM3PM06-P3
	Type	CM3PM mushroom type control set(black)
Applicable products	Ordering code	CM3PM06-P4
	Type	CM3PM mushroom type control set(yellow)
Applicable products		CM3PM05 CM3PM06 CM3PM08

Protruding type(PP)

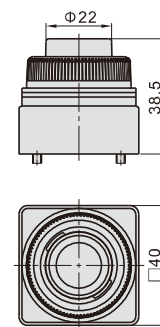

Model		Protruding type (PP)
How to order	Ordering code	CM3PP06-P1
	Type	CM3PP protruding type control set(green)
	Ordering code	CM3PP06-P2
	Type	CM3PP protruding type control set(red)
	Ordering code	CM3PP06-P3
	Type	CM3PP protruding type control set(black)
Applicable products	Ordering code	CM3PP06-P4
	Type	CM3PP protruding type control set(yellow)
Applicable products		CM3PP05 CM3PP06 CM3PP08

Flat type(PF)

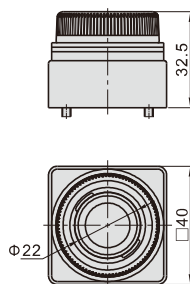

Model		Flat type (PF)
How to order	Ordering code	CM3PF06-P1
	Type	CM3PF flat type control set(green)
	Ordering code	CM3PF06-P2
	Type	CM3PF flat type control set(red)
	Ordering code	CM3PF06-P3
	Type	CM3PF flat type control set(black)
Applicable products	Ordering code	CM3PF06-P4
	Type	CM3PF flat type control set(yellow)
Applicable products		CM3PF05 CM3PF06 CM3PF08

Selector type(HS)

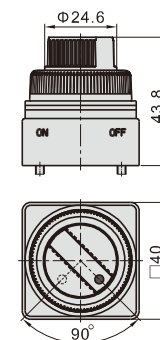

Model		Selector type (HS)
How to order	Ordering code	CM3HS06-P1
	Type	CM3HS selector type control set(green)
	Ordering code	CM3HS06-P2
	Type	CM3HS selector type control set(red)
	Ordering code	CM3HS06-P3
	Type	CM3HS selector type control set(black)
Applicable products	Ordering code	CM3HS06-P4
	Type	CM3HS selector type control set(yellow)
Applicable products		CM3HS05 CM3HS06 CM3HS08

Control valve(3/2 way, 5/3 way)

CM3 Series

Latching type(PL)

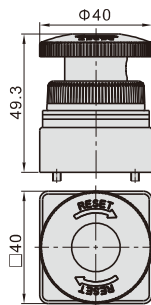

Model	Latching type(PL)
Ordering code	CM3PL06-P2
Type	CM3PL latching type control set(red)
Applicable products	CM3PL05 CM3PL06 CM3PL08

Double-selector type(HD)

CM3HD05

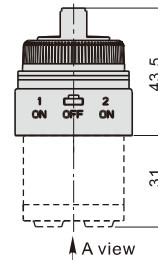
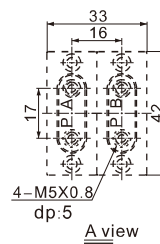

CM3HD06

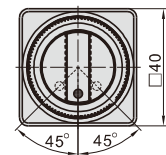
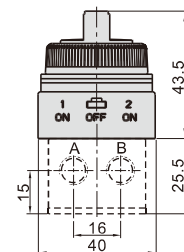
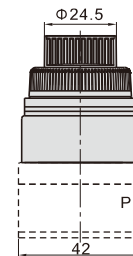
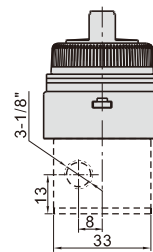

CM3HD08

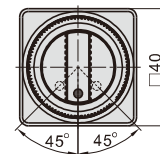
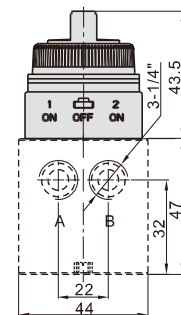
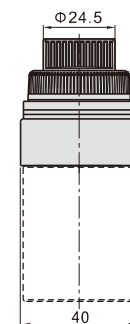
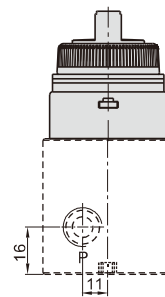

Mushroom type(with guard)(PMS)

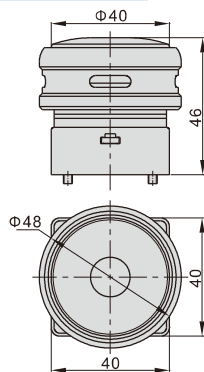

Model	Mushroom type(with guard) (PMS)
Ordering code	CM3PMS06-P1
Type	CM3PMS mushroom type control set(green with guard)
Ordering code	CM3PMS06-P2
Type	CM3PMS mushroom type control set(red with guard)
Ordering code	CM3PMS06-P3
Type	CM3PMS mushroom type control set(black with guard)
Ordering code	CM3PMS06-P4
Type	CM3PMS mushroom type control set(yellow with guard)
Applicable products	CM3PMS05 CM3PMS06 CM3PMS08

Big mushroom type(with guard)(PMX)

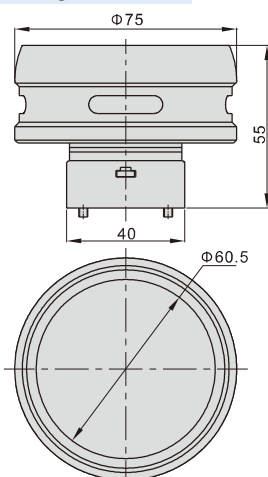

Model	Big mushroom type(with guard)(PMX)
Ordering code	CM3PMX06-P1
Type	CM3PMX big mushroom type control set(green with guard)
Ordering code	CM3PMX06-P2
Type	CM3PMX big mushroom type control set(red with guard)
Ordering code	CM3PMX06-P3
Type	CM3PMX big mushroom type control set(black with guard)
Ordering code	CM3PMX06-P4
Type	CM3PMX big mushroom type control set(yellow with guard)
Applicable products	CM3PMX05 CM3PMX06 CM3PMX08

Model	Double-selector type HD
Ordering code	CM3HD06-P1
Type	CM3HD double-selector type control set(green)
Ordering code	CM3HD06-P2
Type	CM3HD double-selector type control set(red)
Ordering code	CM3HD06-P3
Type	CM3HD double-selector type control set(black)
Ordering code	CM3HD06-P4
Type	CM3HD double-selector type control set(yellow)
Applicable products	CM3HD05 CM3HD06 CM3HD08

Note: CM3HD control joint can be ordered individually, but should be matched with the body of CM3HD.