

Limit Switches **BP series**

Summary

APPROVALS: UL 508 / CSA C22-2 N. 14 / IEC 60947-5-1



CB-SCHEME certification according to IEC 60947-5-1

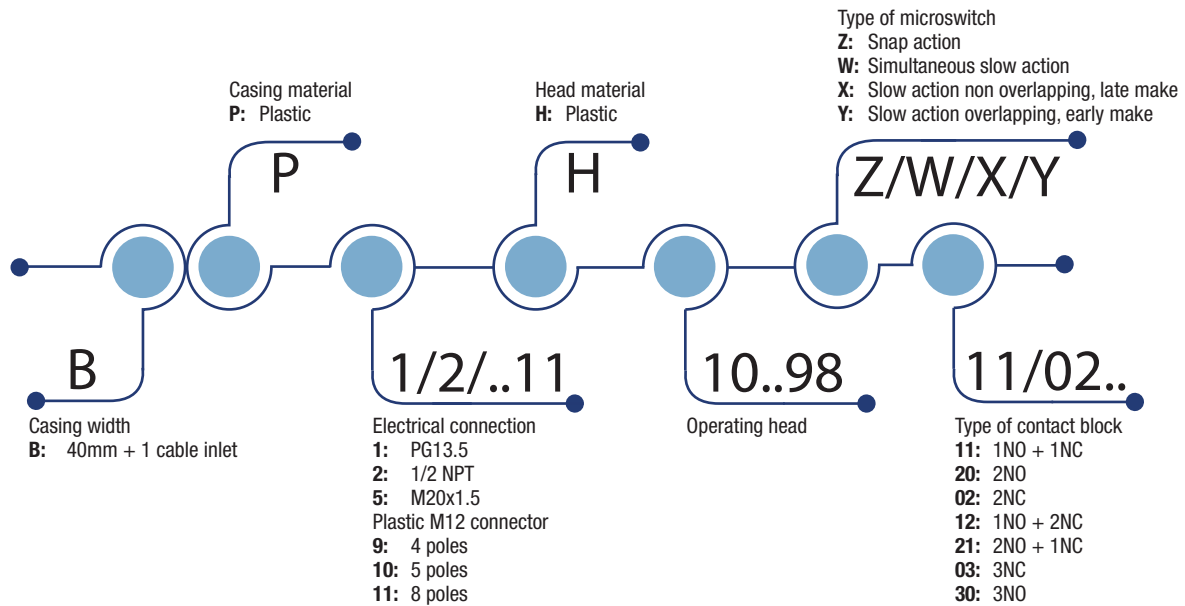

HOW IS IT MADE?

01 A variety of actuators

- Plain plunger
- Roller plunger
- Roller lever, adjustable or not, etc.

02 Wide range of heads

- Assembled using 4 x Ø3 screws

03 Casing:

- 40 mm. with dimensions acc. to EN 50041

04 Mounting screws

- 2 or 4 x M5 screws on top part

05 Cover

- None

06 Contact Block

- Positive opening operation
- Snap action or slow action
- Electrically separated contacts

07 Connecting terminals

- Block of 2 contacts: M3.5 (+, -) pozidriv 2 screw
- Block of 3 contacts: M3 (+, -) screw
- Screw head with captive cable clamp
- Markings conform with IEC 60947-1, IEC 60947-5-1 standards

08 Electrical connection

- 1 x threaded cable inlet suitable for cable gland or M12 connector

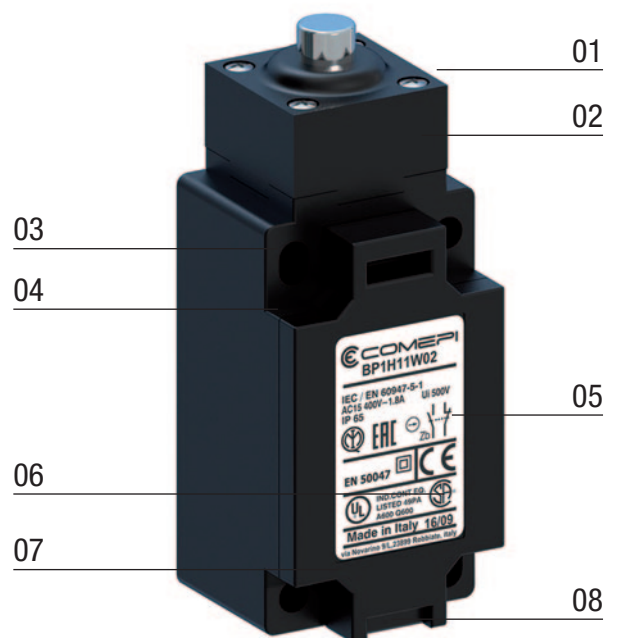

Limit Switches **BP series**

Description

APPLICATIONS

Easy to use, electromechanical limit switches offer specific qualities:

- Visible operation.
- Able to switch strong currents (10 A conventional thermal current).
- Electrically separated contacts.
- Precise operating points (consistency).
- Immune to electromagnetic disturbances.

They are purpose-built detection devices thanks to these characteristics:

- Presence/absence.
- Positioning and travel limit.
- Objects passing/counting.

DESCRIPTION

Limit switches, which are made of reinforced UL-VO thermoplastic fiber-glass, offer double insulation \square and a degree of protection of IP65.

They comply with the requirements of European Directives (Low Voltage and RoHS) and are conform to European and International Standards.

The CE declaration of these products are available in the download section of website www.comepi.it or by writing to the following email address: tecnico@comepi.it
DDC02 - Limit Switches.

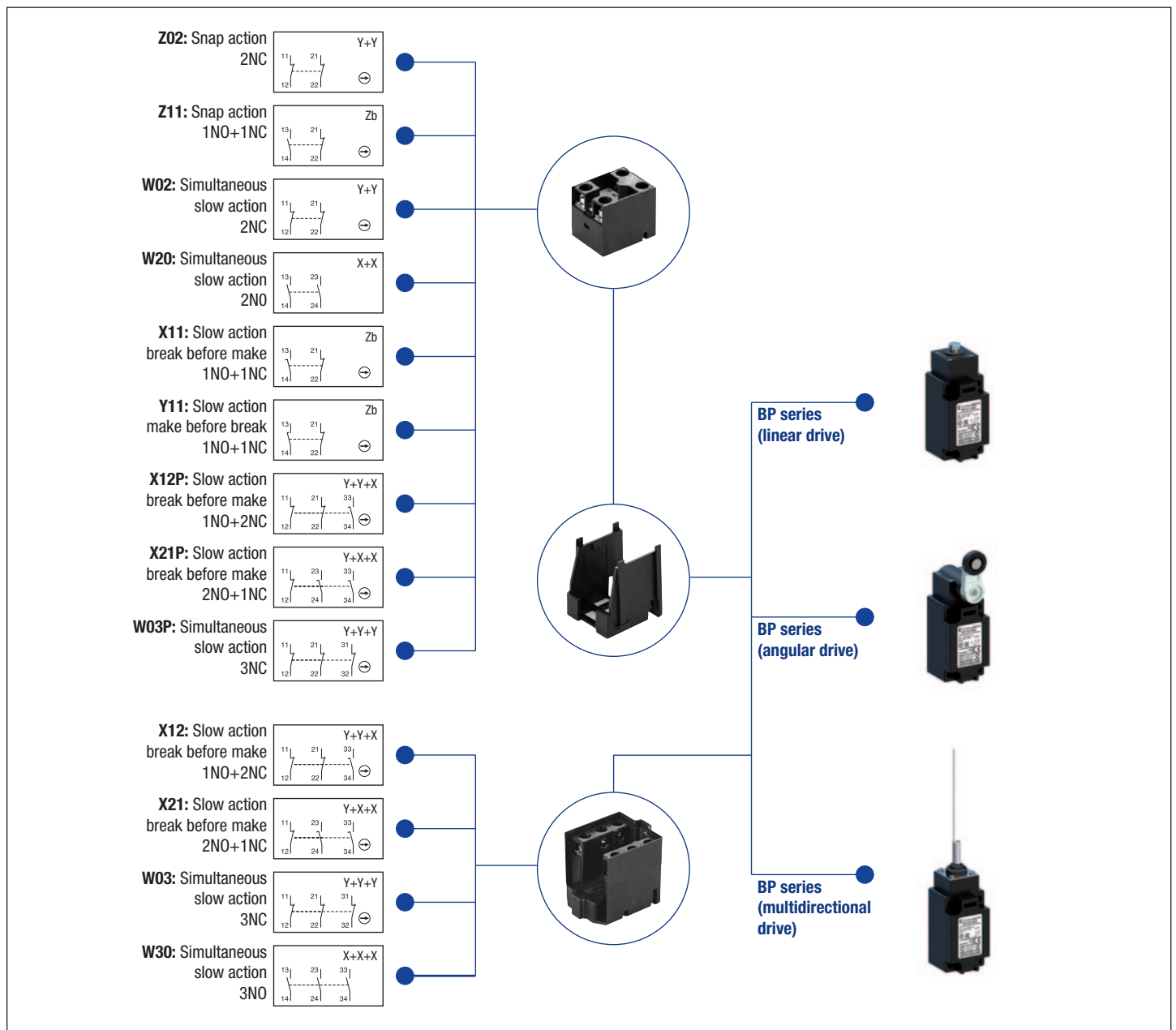

Limit Switches **BP series**

Technical Data

	BP Series	
Standards	IEC 60947-5-1 EN 60947-5-1	
Certifications - Approvals	UL - CSA - IMQ - EAC - CCC - UKCA	
Air temperature near the device		
– during operation	°C	– 25 ... + 70
– for storage	°C	– 30 ... + 80
Mounting positions	All positions are authorised	
Protection against electrical shocks (acc. to IEC 61140)	Class II	
Degree of protection (according to IEC 60529 and EN 60529)	IP65 - IP67	

Electrical Data

Rated insulation voltage U_i - according to IEC 60947-1 and EN 60947-1 - according to UL 508 and CSA C22-2 n° 14	500 V (degree of pollution 3) (400 V for contacts type Z02) A 600, Q 600	
Rated impulse withstand voltage U_{imp} (according to IEC 60947-1 and EN 60947-1)	kV	6
Conventional free air thermal current I_{th} (according to IEC 60947-5-1) $\theta < 40$ °C	A	10
Short-circuit protection $U_e < 500$ V a.c. - gG (gl) type fuses	A	10
Rated operational current I_e / AC-15 (according to IEC 60947-5-1)	24 V - 50/60 Hz A 120 V - 50/60 Hz A 400 V - 50/60 Hz A	10 6 4 (1.8A for contacts type X12, X21, W03, W30)
I_e / DC-13 (according to IEC 60947-5-1)	24 V - d.c. A 125 V - d.c. A 250 V - d.c. A	6 (2.8A for contacts type X12, X21, W03, W30) 0.55 0.4 (0.27A for contacts type X12, X21, W03, W30)
Switching frequency	Cycles/h	3600
Load factor		0.5
Resistance between contacts	m Ω	25
Connecting terminals	M3.5 (+, -) pozidriv 2 screw with cable clamp (M3 for 3 poles contacts type)	
Terminal for protective conductor	-	
Connecting capacity	1 or 2 x mm ²	0.34 ... 2.5 (0.34... 1.5 for 3 poles contacts type)
Terminal marking	According to IEC 60947-5-1	
Recommended tightening torque	Plastic	
Cover	0,5Nm, max 0,8	
Head	0,5Nm, max 0,8	
Microswitch	0,8Nm, max 0,9	
Mechanical durability	30 millions of operations 25 millions of operations 10 millions of operations	H11...13; H31...33 H41...44; H51...54; H61...75 H14; H19; H35...37; H91...93
Electrical durability (according to IEC 60947-5-1)	Utilization categories AC-15 and DC-13 (Load factor of 0.5 according to curves below)	

AC-15 - Snap action

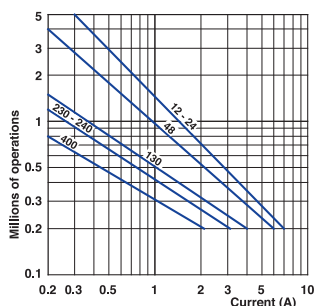

AC-15 - Slow action

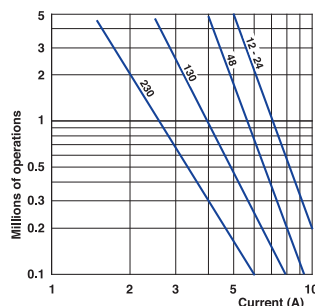

DC-13	Snap action	Slow action
	Power breaking for a durability of 5 million operating cycles	
Voltage 24 V	9.5 W	12 W
Voltage 48 V	6.8 W	9 W
Voltage 110 V	3.6 W	6 W

Limit Switches **BP series**

Technical Data

Technical data approved by IMQ

Standards	Devices conform with international IEC 60947-5-1 and European EN 60947-5-1 standards	
Degree of protection	IP 65	
Rated insulation voltage U_i	500 V (degree of pollution 3) (400V for type Z02)	
Rated impulse withstand voltage U_{imp}	6 kV	
Conventional free air thermal current I_{th}	10 A	
Short-circuit protection - gG (gl) type fuses	10 A	
Rated operational current		
I_e / AC-15	24 V - 50/60 Hz	10 A
	400 V - 50/60 Hz	4 A (1.8A for contacts type X12, X21, W03, W30)
I_e / DC-13	24 V - d.c.	6 A (2.8A for contacts type X12, X21, W03, W30)
	125 V - d.c.	0.55 A
	250 V - d.c.	0.4 A (0.27A for contacts type X12, X21, W03, W30)

Technical data approved by UL

Standards	Devices conform with UL 508
Contact blocks type Z11, X11, Y11, W02 and Z02	
Utilization categories	A600, Q600
Contact blocks type X12, X21, W03 and W30	
Utilization categories	A600, Q600

Use 60/75°C copper (Cu) conductor only. Wire rages 14-18 AWG stranded or solid. The terminal tightening torque of 7 lbs-in / 0.78 Nm. Suitable for conduit connection only with use of adapter sleeve optionally provided or recommended by the manufacturer.

For the complete list of approved products, contact our technical department

IMPLEMENTATION

Operating head orientation

The head can be rotated each 90°. Recommended tightening torque 0,5 Nm (max 0,8 Nm).

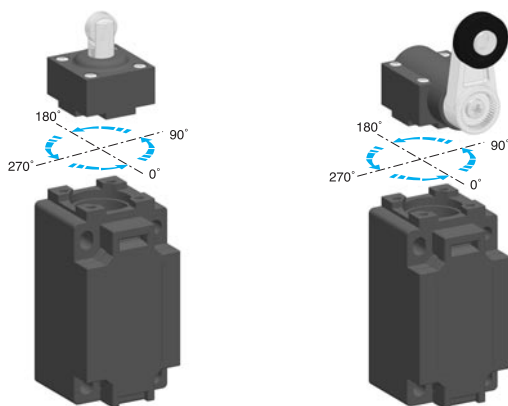

Lever adjustment

The lever of the angular actuators can be adjusted every 9° and round turned in order to obtain the maximum flexibility on the working plan. Recommended tightening torque 0,5 Nm (max 0,8 Nm).

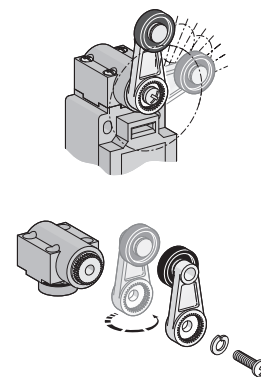

Operating mode selection

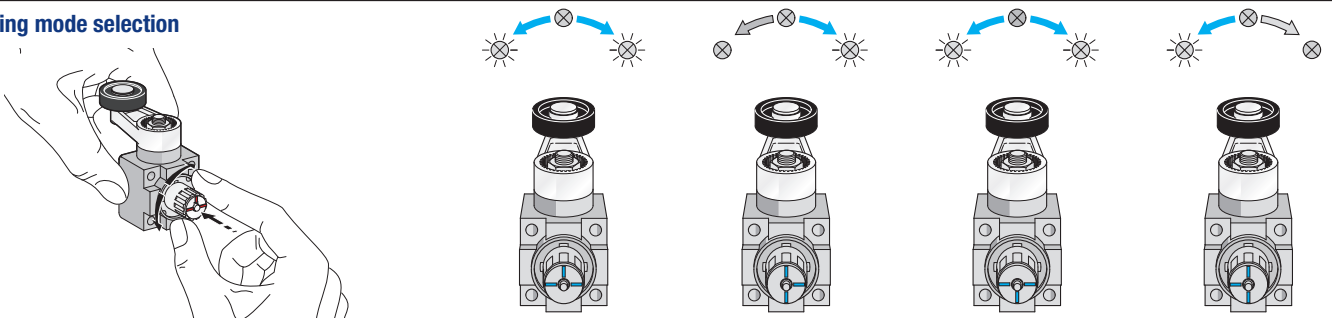

Special Versions

M12 CONNECTOR

Prewired versions with 4, 5 or 8 poles M12 male connectors. Available with plastic threaded body. See page 117 for more details.

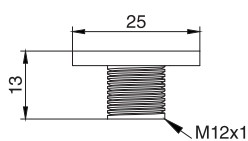

Low Temperature

The limit switches for low temperature applications are useful for refrigerated cells or equipments where the air operational temperature is very low.

These devices, made in special materials, are able to extend the operational temperature range down to -40°C, maintaining mechanical performances intact. To order add the digits "40" following the operating head indication in part number.

For example: BP1H11Z11 ▶ BP1H1140Z11

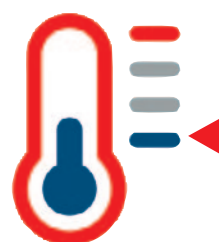

Limit Switches **BP series**

Double Insulation - Plastic Casing IP65 - 40 mm. width

Electrical connection:

- BP1:** one cable inlet for PG 13,5 Cable Gland
- BP2:** one cable inlet for 1/2" NPT Cable Gland
- BP5:** one cable inlet for M20 x 1,5 Cable Gland
- BP9:** 4 poles M12 plastic connector
- BP10:** 5 poles M12 plastic connector
- BP11:** 8 poles M12 plastic connector

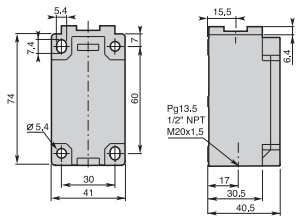

Contact Blocks

Z11 (1NO + 1NC)	BP•H11Z11	BP•H12Z11	BP•H13Z11
X11 (1NO + 1NC)	BP•H11X11	BP•H12X11	BP•H13X11
Y11 (1NO + 1NC)	BP•H11Y11	BP•H12Y11	BP•H13Y11
W02 (2NC)	BP•H11W02	BP•H12W02	BP•H13W02
W20 (2NO)	BP•H11W20	BP•H12W20	BP•H13W20
Z02 (2NC)	BP•H11Z02	BP•H12Z02	BP•H13Z02
X12 (1NO + 2NC)	BP•H11X12	BP•H12X12	BP•H13X12
X21 (2NO + 1NC)	BP•H11X21	BP•H12X21	BP•H13X21
W03 (3NC)	BP•H11W03	BP•H12W03	BP•H13W03
W30 (3NO)	BP•H11W30	BP•H12W30	BP•H13W30

H11 - Plain steel plunger

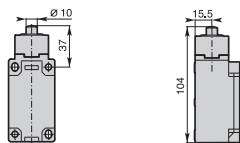

Conformity EN50041
Min. actuating force
Weight

14N (40N ⇄)
145 g

H12 - Steel ball plunger

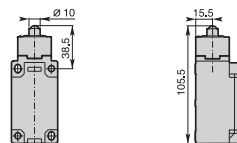

Conformity EN50041
Min. actuating force
Weight

14N (40N ⇄)
145 g

H13 - Steel roller plunger

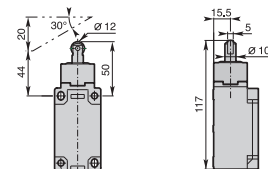

Conformity EN50041
Min. actuating force
Weight

14N (40N ⇄)
150 g

H14 - Plain steel plunger with dust protection cup

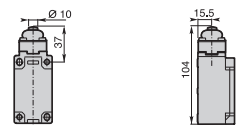

Conformity EN50041
Min. actuating force
Weight

14N (40N ⇄)
145 g

H19 - Steel roller plunger with dust protection cup

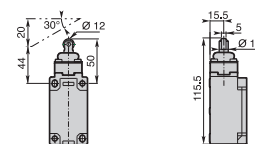

Conformity EN50041
Min. actuating force
Weight

14N (40N ⇄)
150 g

H3 - One way roller

H31: Ø22 nylon roller H32: Ø22 stainless steel roller

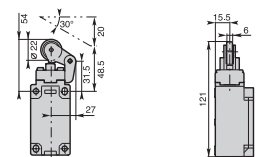

Min. actuating force
Weight

8N (30N ⇄)
185 g

Contact Blocks

Z11 (1NO + 1NC)	BP•H14Z11	BP•H19Z11	BP•H31Z11	BP•H32Z11
X11 (1NO + 1NC)	BP•H14X11	BP•H19X11	BP•H31X11	BP•H32X11
Y11 (1NO + 1NC)	BP•H14Y11	BP•H19Y11	BP•H31Y11	BP•H32Y11
W02 (2NC)	BP•H14W02	BP•H19W02	BP•H31W02	BP•H32W02
W20 (2NO)	BP•H14W20	BP•H19W20	BP•H31W20	BP•H32W20
Z02 (2NC)	BP•H14Z02	BP•H19Z02	BP•H31Z02	BP•H32Z02
X12 (1NO + 2NC)	BP•H14X12	BP•H19X12	BP•H31X12	BP•H32X12
X21 (2NO + 1NC)	BP•H14X21	BP•H19X21	BP•H31X21	BP•H32X21
W03 (3NC)	BP•H14W03	BP•H19W03	BP•H31W03	BP•H32W03
W30 (3NO)	BP•H14W30	BP•H19W30	BP•H31W30	BP•H32W30

Operation diagrams: page 124 - All dimensions are in mm

Limit Switches **BP series**

Double Insulation - Plastic Casing IP65 - 40 mm. width

Electrical connection:

- BP1:** one cable inlet for PG 13,5 Cable Gland
- BP2:** one cable inlet for 1/2" NPT Cable Gland
- BP5:** one cable inlet for M20 x 1,5 Cable Gland
- BP9:** 4 poles M12 plastic connector
- BP10:** 5 poles M12 plastic connector
- BP11:** 8 poles M12 plastic connector

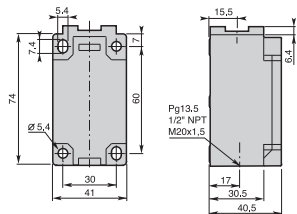

Contact Blocks

Z11 (1NO + 1NC)	BP•H33Z11	BP•H35Z11	BP•H36Z11	BP•H37Z11
X11 (1NO + 1NC)	BP•H33X11	BP•H35X11	BP•H36X11	BP•H37X11
Y11 (1NO + 1NC)	BP•H33Y11	BP•H35Y11	BP•H36Y11	BP•H37Y11
W02 (2NC)	BP•H33W02	BP•H35W02	BP•H36W02	BP•H37W02
W20 (2NO)	BP•H33W20	BP•H35W20	BP•H36W20	BP•H37W20
Z02 (2NC)	BP•H33Z02	BP•H35Z02	BP•H36Z02	BP•H37Z02
X12 (1NO + 2NC)	BP•H33X12	BP•H35X12	BP•H36X12	BP•H37X12
X21 (2NO + 1NC)	BP•H33X21	BP•H35X21	BP•H36X21	BP•H37X21
W03 (3NC)	BP•H33W03	BP•H35W03	BP•H36W03	BP•H37W03
W30 (3NO)	BP•H33W30	BP•H35W30	BP•H36W30	BP•H37W30

H33 - One way roller Ø22 steel ball bearing

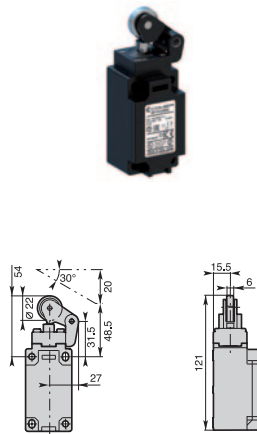

Min. actuating force
Weight

8N (30N ⇄)
185 g

H35 - One way lever with dust protection cup H35: Ø22 nylon roller H36: Ø22 stainless steel roller

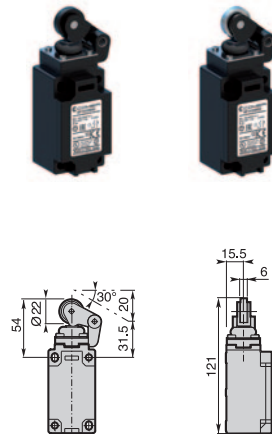

Min. actuating force
Weight

8N (30N ⇄)
180 g

H37 - One way lever with dust protection cup Ø22 steel ball bearing

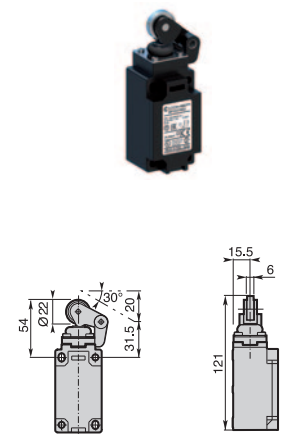

Min. actuating force
Weight

8N (30N ⇄)
180 g

H4• - Ø22 roller lever

H41: nylon roller H42: stainless steel roller

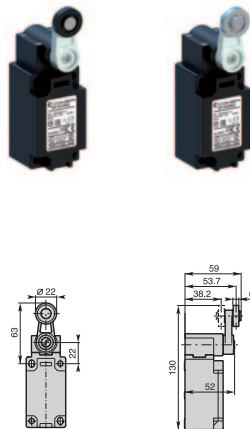

Conformity EN50041
Min. actuating torque
Weight

0,15Nm (0,30Nm ⇄)
200 g

H43 - Ø22 roller lever with steel ball bearing

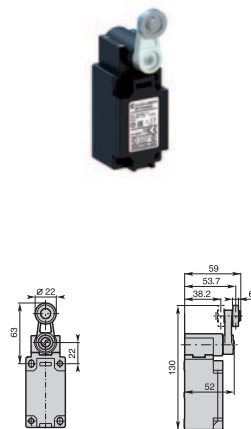

Conformity EN50041
Min. actuating torque
Weight

0,15Nm (0,30Nm ⇄)
200 g

H44 - Ø50 rubber roller lever

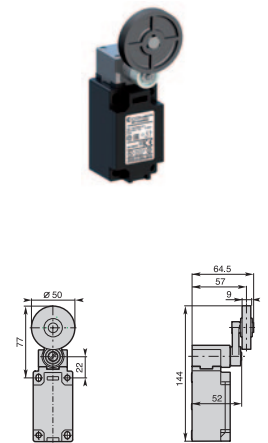

Min. actuating torque
Weight

0,15Nm (0,30Nm ⇄)
205 g

Contact Blocks

Z11 (1NO + 1NC)	BP•H41Z11	BP•H42Z11	BP•H43Z11	BP•H44Z11
X11 (1NO + 1NC)	BP•H41X11	BP•H42X11	BP•H43X11	BP•H44X11
Y11 (1NO + 1NC)	BP•H41Y11	BP•H42Y11	BP•H43Y11	BP•H44Y11
W02 (2NC)	BP•H41W02	BP•H42W02	BP•H43W02	BP•H44W02
W20 (2NO)	BP•H41W20	BP•H42W20	BP•H43W20	BP•H44W20
Z02 (2NC)	BP•H41Z02	BP•H42Z02	BP•H43Z02	BP•H44Z02
X12 (1NO + 2NC)	BP•H41X12	BP•H42X12	BP•H43X12	BP•H44X12
X21 (2NO + 1NC)	BP•H41X21	BP•H42X21	BP•H43X21	BP•H44X21
W03 (3NC)	BP•H41W03	BP•H42W03	BP•H43W03	BP•H44W03
W30 (3NO)	BP•H41W03	BP•H42W30	BP•H43W30	BP•H44W30

Operation diagrams: page 124 - All dimensions are in mm

Limit Switches **BP series**

Double Insulation - Plastic Casing IP65 - 40 mm. width

Electrical connection:

- BP1:** one cable inlet for PG 13,5 Cable Gland
- BP2:** one cable inlet for 1/2" NPT Cable Gland
- BP5:** one cable inlet for M20 x 1,5 Cable Gland
- BP9:** 4 poles M12 plastic connector
- BP10:** 5 poles M12 plastic connector
- BP11:** 8 poles M12 plastic connector

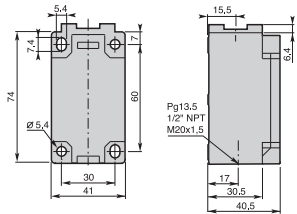

Contact Blocks

Z11 (1NO + 1NC)	BP•H51Z11	BP•H52Z11	BP•H53Z11	BP•H54Z11
X11 (1NO + 1NC)	BP•H51X11	BP•H52X11	BP•H53X11	BP•H54X11
Y11 (1NO + 1NC)	BP•H51Y11	BP•H52Y11	BP•H53Y11	BP•H54Y11
W02 (2NC)	BP•H51W02	BP•H52W02	BP•H53W02	BP•H54W02
W20 (2NO)	BP•H51W20	BP•H52W20	BP•H53W20	BP•H54W20
Z02 (2NC)	BP•H51Z02	BP•H52Z02	BP•H53Z02	BP•H54Z02
X12 (1NO + 2NC)	BP•H51X12	BP•H52X12	BP•H53X12	BP•H54X12
X21 (2NO + 1NC)	BP•H51X21	BP•H52X21	BP•H53X21	BP•H54X21
W03 (3NC)	BP•H51W03	BP•H52W03	BP•H53W03	BP•H54W03
W30 (3NO)	BP•H51W30	BP•H52W30	BP•H53W30	BP•H54W30

H5• - Adjustable Ø22 roller lever

H51: nylon roller H52: stainless steel roller

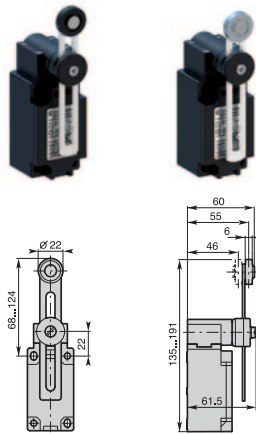

Min. actuating torque **0,15Nm (0,30Nm ⊖)**
Weight **195 g**

H53 - Adjustable Ø22 roller lever with steel ball bearing

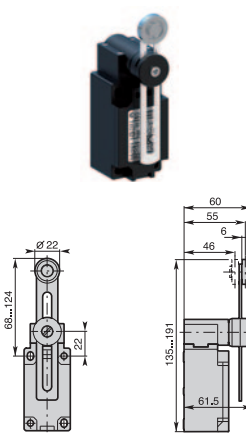

Min. actuating torque **0,15Nm (0,30Nm ⊖)**
Weight **195 g**

H54 - Adjustable Ø50 rubber roller lever

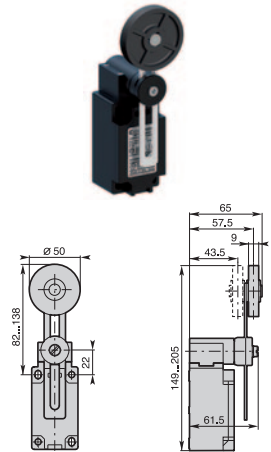

Min. actuating torque **0,15Nm (0,30Nm ⊖)**
Weight **205 g**

H61 - Nylon actuator with stainless steel spring

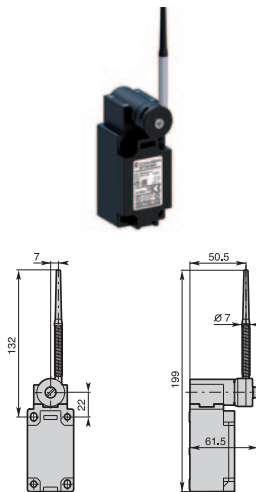

Min. actuating torque **0,15Nm**
Weight **190 g**

H62 - Stainless steel spring actuator

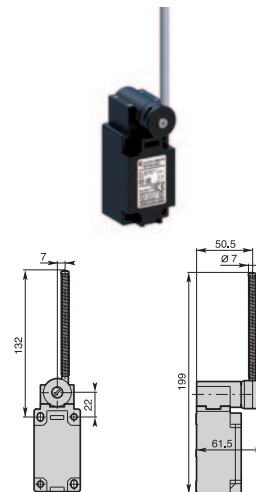

Min. actuating torque **0,15Nm**
Weight **15 g**

H7• - Adjustable Ø3 rod lever

H71: stainless steel rod H73: fiberglass rod

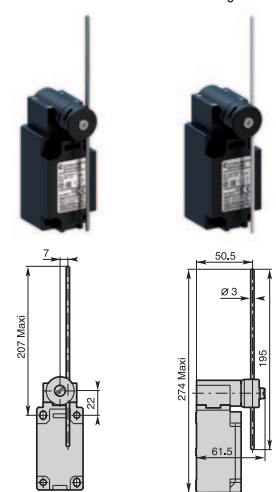

Conformity **EN50041**
Min. actuating torque **0,15Nm (0,30Nm ⊖)**
Weight **185 g**

Contact Blocks

Z11 (1NO + 1NC)	BP•H61Z11	BP•H62Z11	BP•H71Z11	BP•H73Z11
X11 (1NO + 1NC)	BP•H61X11	BP•H62X11	BP•H71X11	BP•H73X11
Y11 (1NO + 1NC)	BP•H61Y11	BP•H62Y11	BP•H71Y11	BP•H73Y11
W02 (2NC)	BP•H61W02	BP•H62W02	BP•H71W02	BP•H73W02
W20 (2NO)	BP•H61W20	BP•H62W20	BP•H71W20	BP•H73W20
Z02 (2NC)	BP•H61Z02	BP•H62Z02	BP•H71Z02	BP•H73Z02
X12 (1NO + 2NC)	BP•H61X12	BP•H62X12	BP•H71X12	BP•H73X12
X21 (2NO + 1NC)	BP•H61X21	BP•H62X21	BP•H71X21	BP•H73X21
W03 (3NC)	BP•H61W03	BP•H62W03	BP•H71W03	BP•H73W03
W30 (3NO)	BP•H61W30	BP•H62W30	BP•H71W30	BP•H73W30

Operation diagrams: page 124 - All dimensions are in mm

Limit Switches **BP series**

Double Insulation - Plastic Casing IP65 - 40 mm. width

Electrical connection:

- BP1:** one cable inlet for PG 13,5 Cable Gland
- BP2:** one cable inlet for 1/2" NPT Cable Gland
- BP5:** one cable inlet for M20 x 1,5 Cable Gland
- BP9:** 4 poles M12 plastic connector
- BP10:** 5 poles M12 plastic connector
- BP11:** 8 poles M12 plastic connector

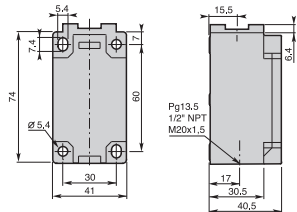

Contact Blocks

Z11 (1NO + 1NC)	BP•H72Z11	BP•H74Z11	BP•H75Z11
X11 (1NO + 1NC)	BP•H72X11	BP•H74X11	BP•H75X11
Y11 (1NO + 1NC)	BP•H72Y11	BP•H74Y11	BP•H75Y11
W02 (2NC)	BP•H72W02	BP•H74W02	BP•H75W02
W20 (2NO)	BP•H72W20	BP•H74W20	BP•H75W20
Z02 (2NC)	BP•H72Z02	BP•H74Z02	BP•H75Z02
X12 (1NO + 2NC)	BP•H72X12	BP•H74X12	BP•H75X12
X21 (2NO + 1NC)	BP•H72X21	BP•H74X21	BP•H75X21
W03 (3NC)	BP•H72W03	BP•H74W03	BP•H75W03
W30 (3NO)	BP•H72W30	BP•H74W30	BP•H75W30

H72 - Adjustable Ø6 nylon rod lever

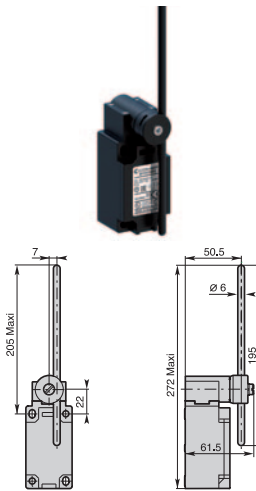

Conformity EN50041

Min. actuating torque 0,15Nm (0,30Nm ⇄)
Weight 185 g

H74 - Adjustable Ø6 fiberglass rod lever

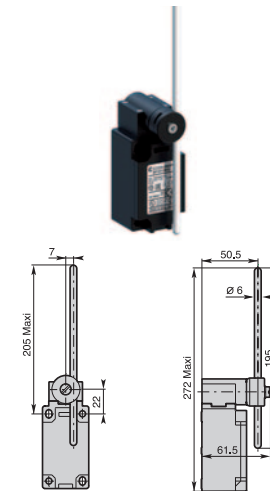

Conformity EN50041

Min. actuating torque 0,15Nm (0,30Nm ⇄)
Weight 185 g

H75 - Adjustable 3x3 square steel rod lever

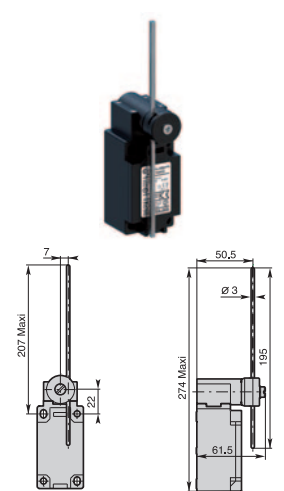

Conformity EN50041

Min. actuating torque 0,15Nm (0,30Nm ⇄)
Weight 185 g

H91 - Stainless steel spring multidirectional actuator

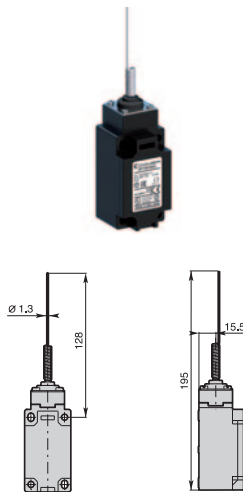

Min. actuating torque 0,18Nm
Weight 150 g

H92 - Multidirectional nylon actuator with stainless steel spring

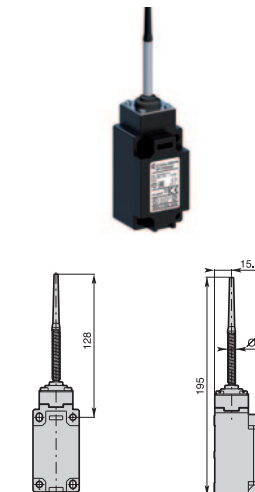

Min. actuating torque 0,18Nm
Weight 155 g

H93 - Stainless steel spring multidirectional actuator

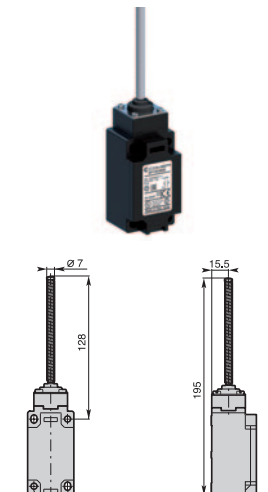

Min. actuating torque 0,18Nm
Weight 160 g

Contact Blocks

Z11 (1NO + 1NC)	BP•H91Z11	BP•H92Z11	BP•H93Z11
X11 (1NO + 1NC)	BP•H91X11	BP•H92X11	BP•H93X11
Y11 (1NO + 1NC)	BP•H91Y11	BP•H92Y11	BP•H93Y11
W02 (2NC)	BP•H91W02	BP•H92W02	BP•H93W02
W20 (2NO)	BP•H91W20	BP•H92W20	BP•H93W20
Z02 (2NC)	BP•H91Z02	BP•H92Z02	BP•H93Z02
X12 (1NO + 2NC)	BP•H91X12	BP•H92X12	BP•H93X12
X21 (2NO + 1NC)	BP•H91X21	BP•H92X21	BP•H93X21
W03 (3NC)	BP•H91W03	BP•H92W03	BP•H93W03
W30 (3NO)	BP•H91W30	BP•H92W30	BP•H93W30

Operation diagrams: page 124 - All dimensions are in mm