

# Limit Switches AP series

## Summary

**APPROVALS:** UL 508 / CSA C22-2 N. 14 / IEC 60947-5-1



CB-SCHEME certification according to IEC 60947-5-1

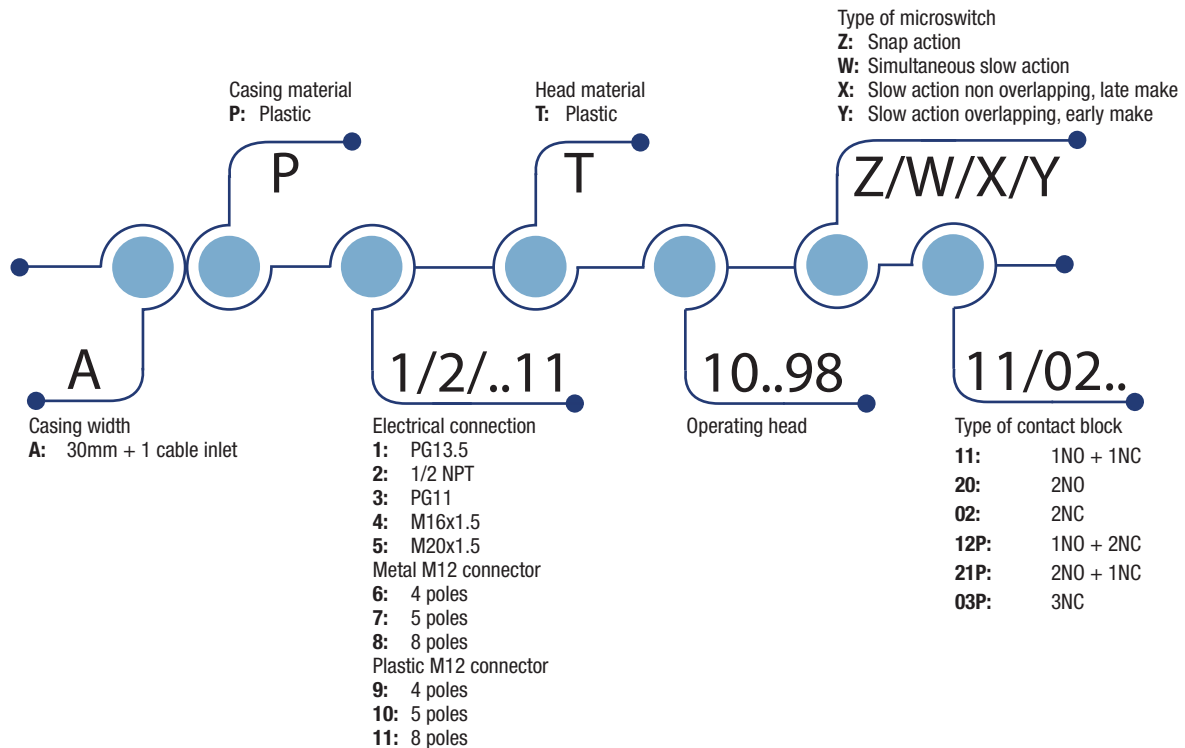

## HOW IS IT MADE?

### 01 A variety of actuators

- Plain plunger
- Roller plunger
- Roller lever, adjustable or not, etc.

### 02 Wide range of heads

- Assembled using 4 x Ø3 screws

### 03 Casing:

- 30 mm. width with standardized dimensions acc. to EN 50047

### 04 Mounting screws

- 2 x M4 screws on top part

### 05 Cover

- 1 screw Ø3 pozidriv 1

### 06 Contact Block

- Positive opening operation
- Snap action or slow action
- Electrically separated contacts

### 07 Connecting terminals

- Block of 2 contacts: M3.5 (+, -) pozidriv 2 screw
- Block of 3 contacts: M3 (+, -) screw
- Screw head with captive cable clamp
- Markings conform with IEC 60947-1, IEC 60947-5-1 standards

### 08 Electrical connection

- 1 x threaded cable entry suitable for cable gland, M12 connector or DEUTSCH connector

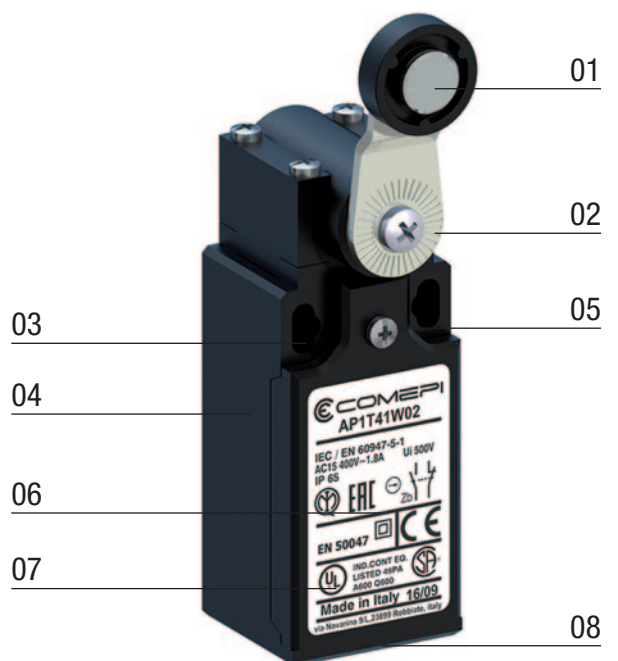

# Limit Switches **AP series**

## Description

### APPLICATIONS

Easy to use, electromechanical limit switches offer specific qualities:

- Visible operation.
- Able to switch strong currents (10 A conventional thermal current).
- Electrically separated contacts.
- Precise operating points (consistency).
- Immune to electromagnetic disturbances.

They are purpose-built detection devices thanks to these characteristics:

- Presence/absence.
- Positioning and travel limit.
- Objects passing/counting.

### DESCRIPTION

Limit switches, which are made of reinforced UL-VO thermoplastic fiber-glass, offer double insulation  and a degree of protection of IP65.

They comply with the requirements of European Directives (Low Voltage and RoHS) and are conform to European and International Standards.

The CE declaration of these products are available in the download section of website [www.comepi.it](http://www.comepi.it) or by writing to the following email address: [tecnico@comepi.it](mailto:tecnico@comepi.it)  
DDC02 - Limit Switches.

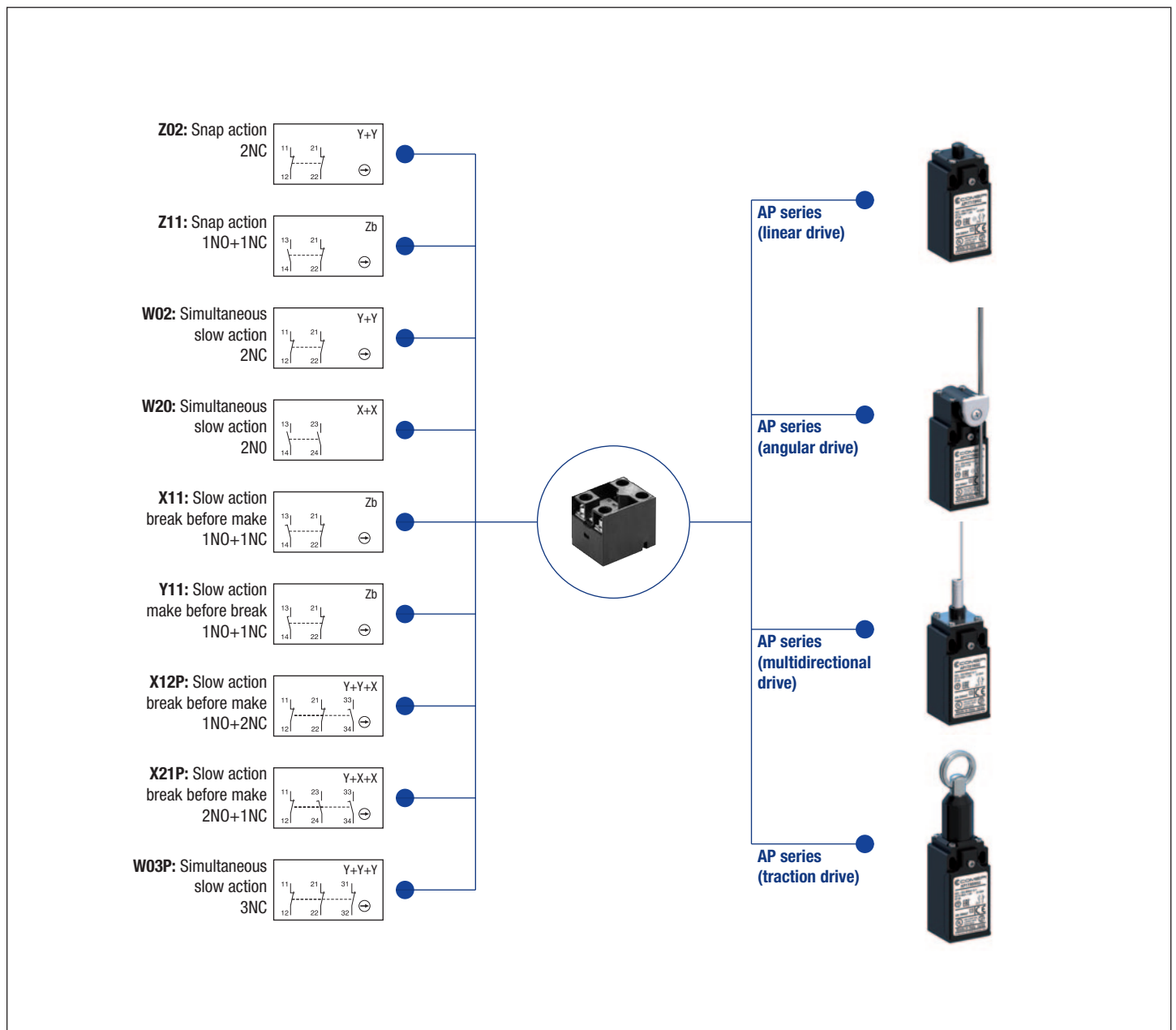

# Limit Switches **AP series**

## Technical Data

	<b>AP Series</b>	
<b>Standards</b>	IEC 60947-5-1 EN 60947-5-1	
<b>Certifications - Approvals</b>	UL - CSA - IMQ - EAC - CCC - UKCA	
<b>Air temperature</b> near the device		
– during operation	°C	– 25 ... + 70
– for storage	°C	– 30 ... + 80
<b>Mounting positions</b>	All positions are authorised	
<b>Protection against electrical shocks</b> (acc. to IEC 61140)	Class II	
<b>Degree of protection</b> (according to IEC 60529 and EN 60529)	IP65 (for all models) - IP67 (only for operating heads from 10 to 39)	

### Electrical Data

<b>Rated insulation voltage <math>U_i</math></b> - according to IEC 60947-1 and EN 60947-1 - according to UL 508 and CSA C22-2 n° 14	500 V (degree of pollution 3) (400 V for contacts type Z02, X12P, X21P, W03P) A 600, Q 600 (A 300, Q 300 for contacts type X12P, X21P, W03P)	
<b>Rated impulse withstand voltage <math>U_{imp}</math></b> (according to IEC 60947-1 and EN 60947-1)	kV	6
<b>Conventional free air thermal current <math>I_{th}</math></b> (according to IEC 60947-5-1) $\theta < 40$ °C	A	10
<b>Short-circuit protection</b> <b><math>U_e &lt; 500</math> V a.c. - gG (gl) type fuses</b>	A	10
<b>Rated operational current</b> <b><math>I_e</math> / AC-15</b> (according to IEC 60947-5-1)	24 V - 50/60 Hz A 120 V - 50/60 Hz A 400 V - 50/60 Hz A	10 6 4
<b><math>I_e</math> / DC-13</b> (according to IEC 60947-5-1)	24 V - d.c. A 125 V - d.c. A 250 V - d.c. A	6 0.55 0.4
<b>Switching frequency</b>	Cycles/h	3600
<b>Load factor</b>		0.5
<b>Resistance between contacts</b>	m $\Omega$	25
<b>Connecting terminals</b>	M3.5 (+, -) pozidriv 2 screw with cable clamp (M3 for 3 poles contacts type)	
<b>Terminal for protective conductor</b>	-	
<b>Recommended tightening torque</b>	<b>Plastic</b>	
<b>Cover</b>	0,5Nm, max 0,8	
<b>Head</b>	0,5Nm, max 0,8	
<b>Microswitch</b>	0,8Nm, max 0,9	
<b>Connecting capacity</b>	1 or 2 x mm <sup>2</sup>	0.34 ... 2.5 (0.34... 1.5 for 3 poles contacts type)
<b>Terminal marking</b>	According to IEC 60947-5-1	
<b>Mechanical durability</b>	15 millions of operations 10 millions of operations >5 millions of operations	T10...12; T21; T2101; T30...34; T38 T13; T41...48; T51...55; T61...75 T14; T35; T36; T39; T91...93; T98
<b>Electrical durability</b> (according to IEC 60947-5-1)	Utilization categories AC-15 and DC-13 (Load factor of 0.5 according to curves below)	

**AC-15 - Snap action**

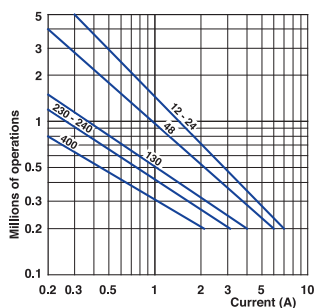

**AC-15 - Slow action**

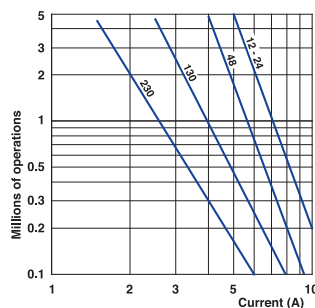

<b>DC-13</b>	<b>Snap action</b>	<b>Slow action</b>
		Power breaking for a durability of 5 million operating cycles
Voltage 24 V	9.5 W	12 W
Voltage 48 V	6.8 W	9 W
Voltage 110 V	3.6 W	6 W

# Limit Switches AP series

## Technical Data

### Technical data approved by IMQ

Standards		Devices conform with international IEC 60947-5-1 and European EN 60947-5-1 standards
Degree of protection	IP 65	
Rated insulation voltage $U_i$	500 V (degree of pollution 3) (400V for type Z02, X12P, X21P, W03P)	
Rated impulse withstand voltage $U_{imp}$	6 kV	
Conventional free air thermal current $I_{th}$	10 A	
Short-circuit protection - gG (gl) type fuses	10 A	
<b>Rated operational current</b>		
$I_e$ / AC-15	24 V - 50/60 Hz	10 A
	400 V - 50/60 Hz	4 A
$I_e$ / DC-13	24 V - d.c.	6 A
	125 V - d.c.	0.55 A
	250 V - d.c.	0.4 A

### IMPLEMENTATION

#### Operating head orientation

The head can be rotated each 90°. Recommended tightening torque 0,5 Nm (max 0,8 Nm).

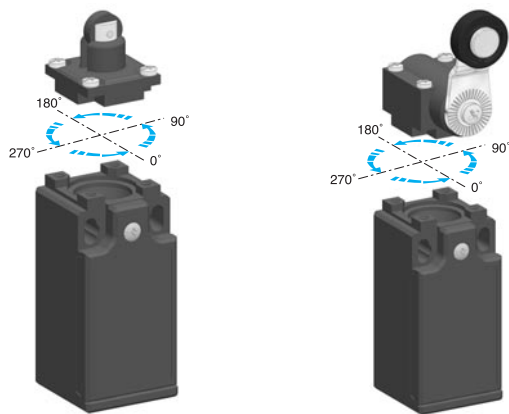

### Technical data approved by UL

Standards		Devices conform with UL 508
<b>Contact blocks type Z11, X11, Y11, W02 and Z02</b>		
Utilization categories	A600, Q600	
<b>Contact blocks type X12P, X21P and W03P</b>		
Utilization categories	A300, Q300	

Use 60/75°C copper (Cu) conductor only. Wire rages 14-18 AWG stranded or solid. The terminal tightening torque of 7 lbs-in / 0.78 Nm. Suitable for conduit connection only with use of adapter sleeve optionally provided or recommended by the manufacturer.

For the complete list of approved products, contact our technical department

#### Lever adjustment

The lever of the angular actuators can be adjusted every 10° and round turned in order to obtain the maximum flexibility on the working plan. Recommended tightening torque 0,5 Nm (max 0,8 Nm).

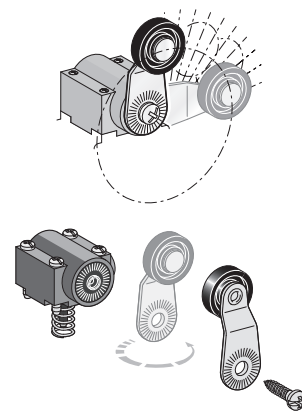

### Special Versions

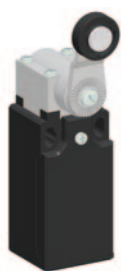

#### Metal actuators

The operating heads used in plastic limit switches AP and DP series have the same dimensions of the ones used in the corresponding metal AM and DM series. It is therefore possible to supply "mixed" versions, that is:

- plastic operating head on metal casing
- metal operating head on plastic casing

#### Manual reset operating head

Limit switches equipped with special operating head with manual reset button.

For more information:



For further informations, please contact our technical department.

#### Low Temperature

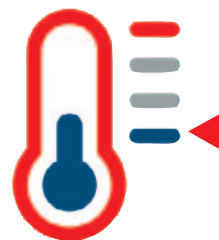

The limit switches for low temperature applications are useful for refrigerated cells or equipments where the air operational temperature is very low. These devices, made in special materials, are able to extend the operational temperature range down to -40°C, maintaining mechanical performances intact.

To order add the digits "40" following the operating head indication in part number.

For example: AP1T10Z11 → AP1T1040Z11

# Limit Switches AP\_T series

Double insulation - Plastic casing IP65 - 30 mm. width

## Electrical connection:

- AP1: one cable inlet for PG 13,5 Cable Gland
- AP2: one cable inlet by 1/2" NPT Plastic Adapter
- AP3: one cable inlet for PG11 Cable Gland
- AP4: one cable inlet for M16 x 1,5 Cable Gland
- AP5: one cable inlet for M20 x 1,5 Cable Gland
- AP6: 4 poles M12 metal connector
- AP7: 5 poles M12 metal connector
- AP8: 8 poles M12 metal connector
- AP9: 4 poles M12 plastic connector
- AP10: 5 poles M12 plastic connector
- AP11: 8 poles M12 plastic connector

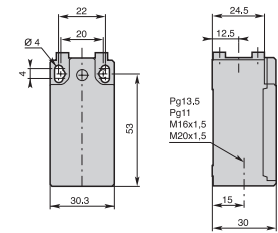

## Contact Blocks

Z11 (1NO + 1NC)	AP•T10Z11	AP•T11Z11	AP•T12Z11	AP•T13Z11	AP•T14Z11
X11 (1NO + 1NC)	AP•T10X11	AP•T11X11	AP•T12X11	AP•T13X11	AP•T14X11
Y11 (1NO + 1NC)	AP•T10Y11	AP•T11Y11	AP•T12Y11	AP•T13Y11	AP•T14Y11
W02 (2NC)	AP•T10W02	AP•T11W02	AP•T12W02	AP•T13W02	AP•T14W02
W20 (2NO)	AP•T10W20	AP•T11W20	AP•T12W20	AP•T13W20	AP•T14W20
Z02 (2NC)	AP•T10Z02	AP•T11Z02	AP•T12Z02	AP•T13Z02	AP•T14Z02
X12P (1NO + 2NC)	AP•T10X12P	AP•T11X12P	AP•T12X12P	AP•T13X12P	AP•T14X12P
X21P (2NO + 1NC)	AP•T10X21P	AP•T11X21P	AP•T12X21P	AP•T13X21P	AP•T14X21P
W03P (3NC)	AP•T10W03P	AP•T11W03P	AP•T12W03P	AP•T13W03P	AP•T14W03P

## T1• - Plain plunger

T10: nylon plunger T11: metal plunger

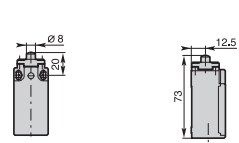

Conformity EN50047  
Min. actuating force  
Weight

15N (30N ⇄)  
70 g

## T1• - Roller plunger

T12: metal roller T13: nylon roller

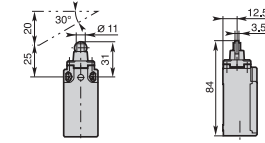

Conformity EN50047  
Min. actuating force  
Weight

12N (30N ⇄)  
75 g

## T14 - Metal plunger with dust protection cup

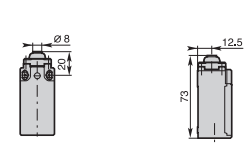

Conformity EN50047  
Min. actuating force  
Weight

15N (30N ⇄)  
70 g

## T21 - Plain plunger with M18x1 fixing nuts

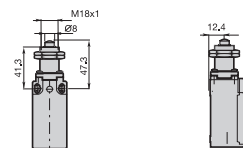

Min. actuating force  
Weight

15N (30N ⇄)  
80 g

## T2101 - Plain plunger with M12x1 fixing nuts

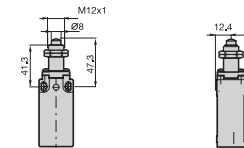

Min. actuating force  
Weight

15N (30N ⇄)  
80 g

## T3• - Plastic roller lever

T30: on plastic plunger T31: on metal plunger

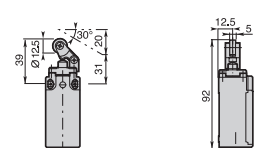

Conformity EN50047  
Min. actuating force  
Weight

7N (24N ⇄)  
75 g

## Contact Blocks

Z11 (1NO + 1NC)	AP•T21Z11	AP•T2101Z11	AP•T30Z11	AP•T31Z11
X11 (1NO + 1NC)	AP•T21X11	AP•T2101X11	AP•T30X11	AP•T31X11
Y11 (1NO + 1NC)	AP•T21Y11	AP•T2101Y11	AP•T30Y11	AP•T31Y11
W02 (2NC)	AP•T21W02	AP•T2101W02	AP•T30W02	AP•T31W02
W20 (2NO)	AP•T21W20	AP•T2101W20	AP•T30W20	AP•T31W20
Z02 (2NC)	AP•T21Z02	AP•T2101Z02	AP•T30Z02	AP•T31Z02
X12P (1NO + 2NC)	AP•T21X12P	AP•T2101X12P	AP•T30X12P	AP•T31X12P
X21P (2NO + 1NC)	AP•T21X21P	AP•T2101X21P	AP•T30X21P	AP•T31X21P
W03P (3NC)	AP•T21W03P	AP•T2101W03P	AP•T30W03P	AP•T31W03

Operation diagrams: page 123 - All dimensions are in mm

# Limit Switches AP\_T series

## Double insulation - Plastic casing IP65 - 30 mm. width

### Electrical connection:

- AP1: one cable inlet for PG 13,5 Cable Gland
- AP2: one cable inlet by 1/2" NPT Plastic Adapter
- AP3: one cable inlet for PG11 Cable Gland
- AP4: one cable inlet for M16 x 1,5 Cable Gland
- AP5: one cable inlet for M20 x 1,5 Cable Gland
- AP6: 4 poles M12 metal connector
- AP7: 5 poles M12 metal connector
- AP8: 8 poles M12 metal connector
- AP9: 4 poles M12 plastic connector
- AP10: 5 poles M12 plastic connector
- AP11: 8 poles M12 plastic connector

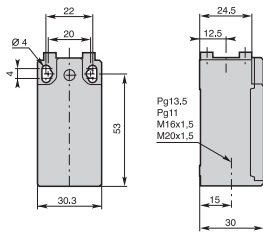

### Contact Blocks

Z11 (1NO + 1NC)	AP•T32Z11	AP•T34Z11	AP•T35Z11	AP•T36Z11
X11 (1NO + 1NC)	AP•T32X11	AP•T34X11	AP•T35X11	AP•T36X11
Y11 (1NO + 1NC)	AP•T32Y11	AP•T34Y11	AP•T35Y11	AP•T36Y11
W02 (2NC)	AP•T32W02	AP•T34W02	AP•T35W02	AP•T36W02
W20 (2NO)	AP•T32W20	AP•T34W20	AP•T35W20	AP•T36W20
Z02 (2NC)	AP•T32Z02	AP•T34Z02	AP•T35Z02	AP•T36Z02
X12P (1NO + 2NC)	AP•T32X12P	AP•T34X12P	AP•T35X12P	AP•T36X12P
X21P (2NO + 1NC)	AP•T32X21P	AP•T34X21P	AP•T35X21P	AP•T36X21P
W03P (3NC)	AP•T32W03P	AP•T34W03P	AP•T35W03P	AP•T36W03P

### T3 - Plastic roller lever

T32: on metal plunger T34: on plastic plunger

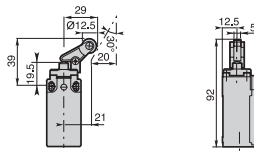

Min. actuating force  
Weight

7N (24N ⇄)  
80 g

### T35 - Plastic roller lever on metal plunger with dust protection cup

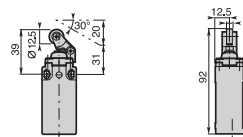

Conformity EN50047  
Min. actuating force  
Weight

7N (24N ⇄)  
75 g

### T36 - Plastic roller lever on metal plunger with dust protection cup

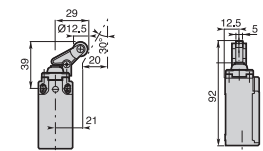

Min. actuating force  
Weight

7N (24N ⇄)  
80 g

### T38 - Adjustable plastic roller lever on metal plunger

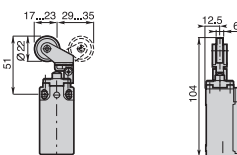

Conformity EN50047  
Min. actuating force  
Weight

7N (24N ⇄)  
80 g

### T39 - Adjustable plastic roller lever on metal plunger with dust protection cup

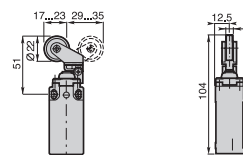

Conformity EN50047  
Min. actuating force  
Weight

7N (24N ⇄)  
80 g

### T41 - Ø 18 nylon roller lever

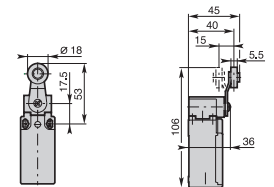

Conformity EN50047  
Min. actuating torque  
Weight

0,10Nm (0,32Nm ⇄)  
95 g

### Contact Blocks

Z11 (1NO + 1NC)	AP•T38Z11	AP•T39Z11	AP•T41Z11
X11 (1NO + 1NC)	AP•T38X11	AP•T39X11	AP•T41X11
Y11 (1NO + 1NC)	AP•T38Y11	AP•T39Y11	AP•T41Y11
W02 (2NC)	AP•T38W02	AP•T39W02	AP•T41W02
W20 (2NO)	AP•T38W20	AP•T39W20	AP•T41W20
Z02 (2NC)	AP•T38Z02	AP•T39Z02	AP•T41Z02
X12P (1NO + 2NC)	AP•T38X12P	AP•T39X12P	AP•T41X12P
X21P (2NO + 1NC)	AP•T38X21P	AP•T39X21P	AP•T41X21P
W03P (3NC)	AP•T38W03P	AP•T39W03P	AP•T41W03P

Operation diagrams: page 123 - All dimensions are in mm

# Limit Switches AP\_T series

## Double insulation - Plastic casing IP65 - 30 mm. width

### Electrical connection:

- AP1: one cable inlet for PG 13,5 Cable Gland
- AP2: one cable inlet by 1/2" NPT Plastic Adapter
- AP3: one cable inlet for PG11 Cable Gland
- AP4: one cable inlet for M16 x 1,5 Cable Gland
- AP5: one cable inlet for M20 x 1,5 Cable Gland
- AP6: 4 poles M12 metal connector
- AP7: 5 poles M12 metal connector
- AP8: 8 poles M12 metal connector
- AP9: 4 poles M12 plastic connector
- AP10: 5 poles M12 plastic connector
- AP11: 8 poles M12 plastic connector

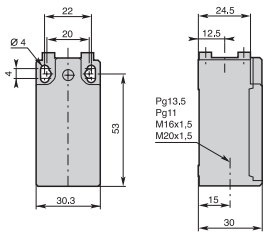

### Contact Blocks

- Z11 (1NO + 1NC)
- X11 (1NO + 1NC)
- Y11 (1NO + 1NC)
- W02 (2NC)
- W20 (2NO)
- Z02 (2NC)
- X12P (1NO + 2NC)
- X21P (2NO + 1NC)
- W03P (3NC)

### T42 - Ø 50 rubber roller lever

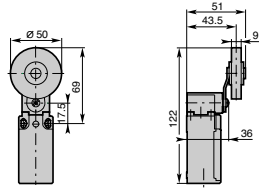

Min. actuating torque 0,10Nm (0,32Nm ⊖)  
Weight 115 g

### T43 - Ø 18 metal roller lever

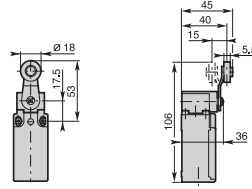

Conformity EN50047

Min. actuating torque 0,10Nm (0,32Nm ⊖)  
Weight 100 g

### T45 - Ø 18 nylon roller lever

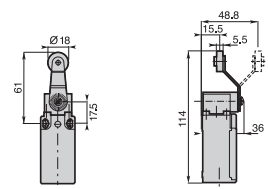

Min. actuating torque 0,10Nm (0,32Nm ⊖)  
Weight 95 g

### T46 - Ø 18 metal roller lever

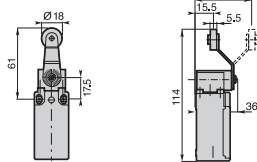

Min. actuating torque 0,10Nm (0,32Nm ⊖)  
Weight 100 g

### T48 - Ceramic rod lever

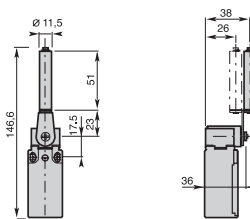

Min. actuating torque 0,10Nm (0,32Nm ⊖)  
Weight 100 g

### T51 - Adjustable lever with Ø 18 nylon roller

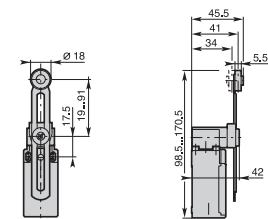

Min. actuating torque 0,10Nm (0,32Nm ⊖)  
Weight 100 g

### Contact Blocks

- Z11 (1NO + 1NC)
- X11 (1NO + 1NC)
- Y11 (1NO + 1NC)
- W02 (2NC)
- W20 (2NO)
- Z02 (2NC)
- X12P (1NO + 2NC)
- X21P (2NO + 1NC)
- W03P (3NC)

- AP•T46Z11
- AP•T46X11
- AP•T46Y11
- AP•T46W02
- AP•T46W20
- AP•T46Z02
- AP•T46X12P
- AP•T46X21P
- AP•T46W03P

- AP•T48Z11
- AP•T48X11
- AP•T48Y11
- AP•T48W02
- AP•T48W20
- AP•T48Z02
- AP•T48X12P
- AP•T48X21P
- AP•T48W03P

- AP•T51Z11
- AP•T51X11
- AP•T51Y11
- AP•T51W02
- AP•T51W20
- AP•T51Z02
- AP•T51X12P
- AP•T51X21P
- AP•T51W03P

# Limit Switches AP\_T series

## Double insulation - Plastic casing IP65 - 30 mm. width

### Electrical connection:

- AP1: one cable inlet for PG 13,5 Cable Gland
- AP2: one cable inlet by 1/2" NPT Plastic Adapter
- AP3: one cable inlet for PG11 Cable Gland
- AP4: one cable inlet for M16 x 1,5 Cable Gland
- AP5: one cable inlet for M20 x 1,5 Cable Gland
- AP6: 4 poles M12 metal connector
- AP7: 5 poles M12 metal connector
- AP8: 8 poles M12 metal connector
- AP9: 4 poles M12 plastic connector
- AP10: 5 poles M12 plastic connector
- AP11: 8 poles M12 plastic connector

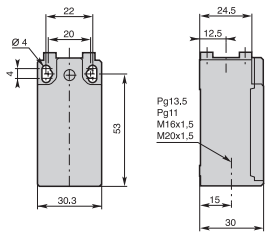

### Contact Blocks

- Z11 (1NO + 1NC)
- X11 (1NO + 1NC)
- Y11 (1NO + 1NC)
- W02 (2NC)
- W20 (2NO)
- Z02 (2NC)
- X12P (1NO + 2NC)
- X21P (2NO + 1NC)
- W03P (3NC)

### T5100 - Adjustable toothed lever (step 2 mm) with Ø 18 nylon roller

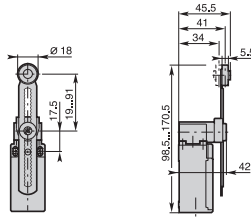

Min. actuating torque 0,10Nm (0,32Nm ⊖)  
Weight 105 g

### T52 - Adjustable lever with Ø 50 rubber roller

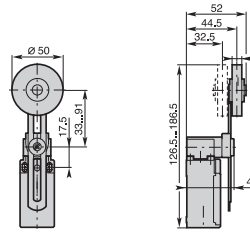

Min. actuating torque 0,10Nm (0,32Nm ⊖)  
Weight 125 g

### T5200 - Adjustable toothed lever (step 2 mm) with Ø 50 rubber roller

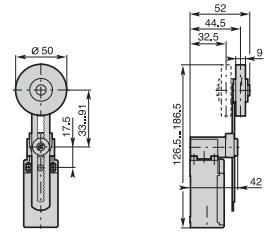

Min. actuating torque 0,10Nm (0,32Nm ⊖)  
Weight 125 g

Z11 (1NO + 1NC)	AP•T5100Z11	AP•T52Z11	AP•T5200Z11
X11 (1NO + 1NC)	AP•T5100X11	AP•T52X11	AP•T5200X11
Y11 (1NO + 1NC)	AP•T5100Y11	AP•T52Y11	AP•T5200Y11
W02 (2NC)	AP•T5100W02	AP•T52W02	AP•T5200W02
W20 (2NO)	AP•T5100W20	AP•T52W20	AP•T5200W20
Z02 (2NC)	AP•T5100Z02	AP•T52Z02	AP•T5200Z02
X12P (1NO + 2NC)	AP•T5100X12P	AP•T52X12P	AP•T5200X12P
X21P (2NO + 1NC)	AP•T5100X21P	AP•T52X21P	AP•T5200X21P
W03P (3NC)	AP•T5100W03P	AP•T52W03P	AP•T5200W03P

### T53 - Adjustable lever with Ø 18 metal roller

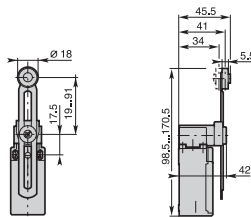

Min. actuating torque 0,10Nm (0,32Nm ⊖)  
Weight 110 g

### T55 - Adjustable lever with adjustable Ø 50 rubber roller

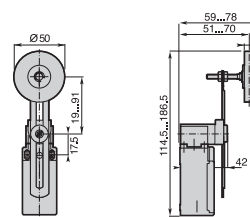

Min. actuating torque 0,10Nm (0,32Nm ⊖)  
Weight 130 g

### T5500 - Adjustable toothed lever (step 2 mm) with adjustable Ø 50 rubber roller

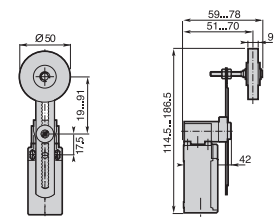

Min. actuating torque 0,10Nm (0,32Nm ⊖)  
Weight 130 g

### Contact Blocks

Z11 (1NO + 1NC)	AP•T53Z11	AP•T55Z11	AP•T5500Z11
X11 (1NO + 1NC)	AP•T53X11	AP•T55X11	AP•T5500X11
Y11 (1NO + 1NC)	AP•T53Y11	AP•T55Y11	AP•T5500Y11
W02 (2NC)	AP•T53W02	AP•T55W02	AP•T5500W02
W20 (2NO)	AP•T53W20	AP•T55W20	AP•T5500W20
Z02 (2NC)	AP•T53Z02	AP•T55Z02	AP•T5500Z02
X12P (1NO + 2NC)	AP•T53X12P	AP•T55X12P	AP•T5500X12P
X21P (2NO + 1NC)	AP•T53X21P	AP•T55X21P	AP•T5500X21P
W03P (3NC)	AP•T53W03P	AP•T55W03P	AP•T5500W03P

Operation diagrams: page 123 - All dimensions are in mm



# Limit Switches AP\_T series

## Double insulation - Plastic casing IP65 - 30 mm. width

### Electrical connection:

- AP1: one cable inlet for PG 13,5 Cable Gland
- AP2: one cable inlet by 1/2" NPT Plastic Adapter
- AP3: one cable inlet for PG11 Cable Gland
- AP4: one cable inlet for M16 x 1,5 Cable Gland
- AP5: one cable inlet for M20 x 1,5 Cable Gland
- AP6: 4 poles M12 metal connector
- AP7: 5 poles M12 metal connector
- AP8: 8 poles M12 metal connector
- AP9: 4 poles M12 plastic connector
- AP10: 5 poles M12 plastic connector
- AP11: 8 poles M12 plastic connector

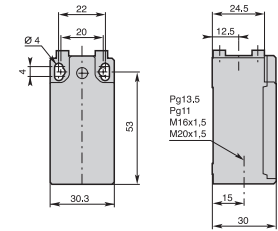

### Contact Blocks

- Z11 (1NO + 1NC)
- X11 (1NO + 1NC)
- Y11 (1NO + 1NC)
- W02 (2NC)
- W20 (2NO)
- Z02 (2NC)
- X12P (1NO + 2NC)
- X21P (2NO + 1NC)
- W03P (3NC)

### T61 - Nylon actuator with stainless steel spring

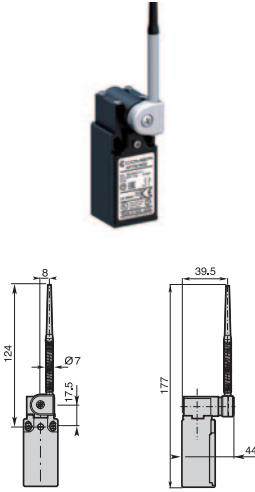

Min. actuating torque 0,10Nm  
Weight 105 g

### T62 - Stainless steel spring actuator

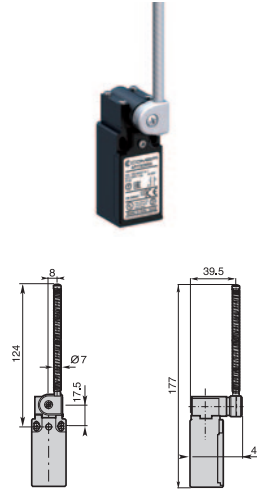

Min. actuating torque 0,10Nm  
Weight 105 g

### T71 - Adjustable Ø 3 rod lever with stainless steel rod

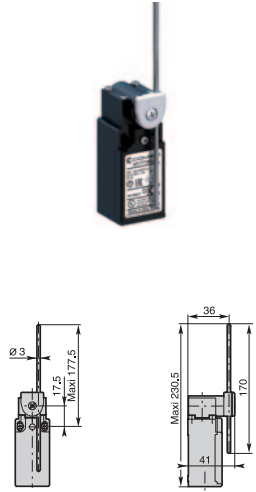

Min. actuating torque 0,10Nm (0,32Nm ⊖)  
Weight 105 g

### T72 - Adjustable Ø 3 rod lever with fiberglass rod

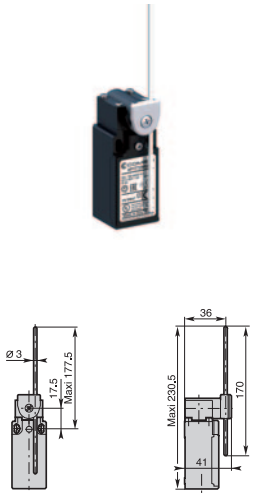

Min. actuating torque 0,10Nm (0,32Nm ⊖)  
Weight 105 g

### T73 - Adjustable Ø 6 rod lever with nylon rod

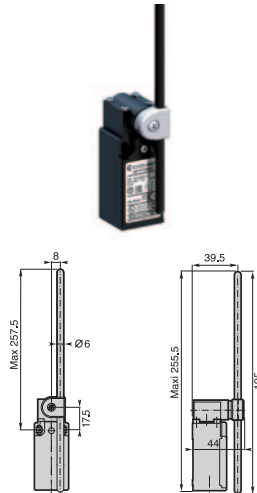

Min. actuating torque 0,10Nm (0,32Nm ⊖)  
Weight 115 g

### T74 - Adjustable Ø 6 rod lever with fiberglass rod

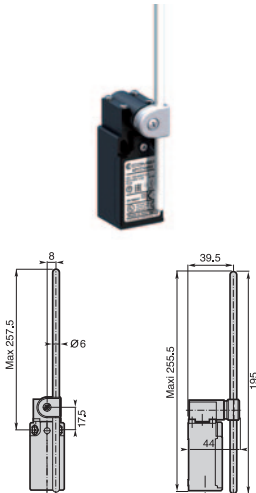

Min. actuating torque 0,10Nm (0,32Nm ⊖)  
Weight 115 g

### Contact Blocks

- Z11 (1NO + 1NC)
- X11 (1NO + 1NC)
- Y11 (1NO + 1NC)
- W02 (2NC)
- W20 (2NO)
- Z02 (2NC)
- X12P (1NO + 2NC)
- X21P (2NO + 1NC)
- W03P (3NC)

- AP•T72Z11
- AP•T72X11
- AP•T72Y11
- AP•T72W02
- AP•T72W20
- AP•T72Z02
- AP•T72X12P
- AP•T72X21P
- AP•T72W03P

- AP•T73Z11
- AP•T73X11
- AP•T73Y11
- AP•T73W02
- AP•T73W20
- AP•T73Z02
- AP•T73X12P
- AP•T73X21P
- AP•T73W03P

- AP•T74Z11
- AP•T74X11
- AP•T74Y11
- AP•T74W02
- AP•T74W20
- AP•T74Z02
- AP•T74X12P
- AP•T74X21P
- AP•T74W03P

# Limit Switches AP\_T series

Double insulation - Plastic casing IP65 - 30 mm. width

## Electrical connection:

- AP1: one cable inlet for PG 13,5 Cable Gland
- AP2: one cable inlet by 1/2" NPT Plastic Adapter
- AP3: one cable inlet for PG11 Cable Gland
- AP4: one cable inlet for M16 x 1,5 Cable Gland
- AP5: one cable inlet for M20 x 1,5 Cable Gland
- AP6: 4 poles M12 metal connector
- AP7: 5 poles M12 metal connector
- AP8: 8 poles M12 metal connector
- AP9: 4 poles M12 plastic connector
- AP10: 5 poles M12 plastic connector
- AP11: 8 poles M12 plastic connector

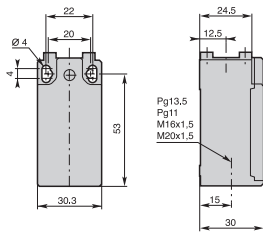

## Contact Blocks

- Z11 (1NO + 1NC)
- X11 (1NO + 1NC)
- Y11 (1NO + 1NC)
- W02 (2NC)
- W20 (2NO)
- Z02 (2NC)
- X12P (1NO + 2NC)
- X21P (2NO + 1NC)
- W03P (3NC)

## T75 - Adjustable 3x3 square steel rod lever

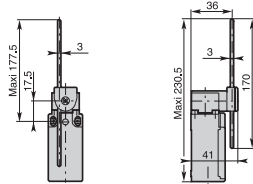

Min. actuating torque 0,10Nm (0,32Nm ⊖)  
Weight 105 g

## T91 - Stainless steel spring multidirectional actuator

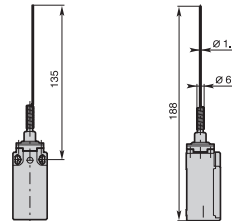

Min. actuating torque 0,12Nm  
Weight 80 g

## T92 - Multidirectional nylon actuator with stainless steel spring

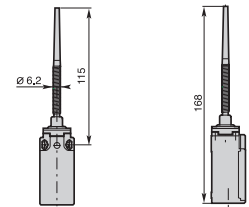

Min. actuating torque 0,12Nm  
Weight 85 g

## T93 - Stainless steel spring multidirectional actuator

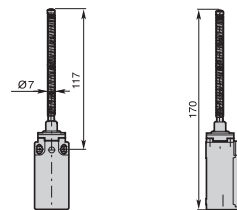

Min. actuating torque 0,12Nm  
Weight 90 g

## T98 - Pull action with ring

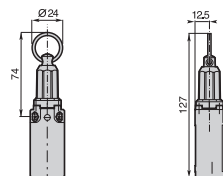

Min. actuating force 15N  
Weight 115 g

## Contact Blocks

- Z11 (1NO + 1NC)
- X11 (1NO + 1NC)
- Y11 (1NO + 1NC)
- W02 (2NC)
- W20 (2NO)
- Z02 (2NC)
- X12P (1NO + 2NC)
- X21P (2NO + 1NC)
- W03P (3NC)

- AP•T93Z11
- AP•T93X11
- AP•T93Y11
- AP•T93W02
- AP•T93W20
- AP•T93Z02
- AP•T93X12P
- AP•T93X21P
- AP•T93W03P

- AP•T98Z11A
- AP•T98X11A
- AP•T98Y11A
- AP•T98W02A
- AP•T98W20A

Operation diagrams: page 123 - All dimensions are in mm