

# Fluid control valve (2/2way)

## 2V Series



### Symbol



### Product feature

#### 2V025 series

1. Direct acting and normally closed type 2/2 way solenoid valve. Its high sensitivity allows it to change direction quickly.
2. The structure is small and compact.
3. The valve body is made of brass which is heat resistance and the coil conforms to Class B classification. The seals are made of fluorine rubber (VITON) which is suitable for several types of working medium.

#### 2V130 and 250 series

1. This 2/2 way diaphragm piloted solenoid valve has low energy consumption and large air flow.
2. The starting pressure is low and the operational differential pressure is <math>< 0.05\text{MPa}</math>.
3. The valve body is made of brass which is heat resistance and the coil conforms to Class B classification. The seals are made of NBR.

### Inner structure

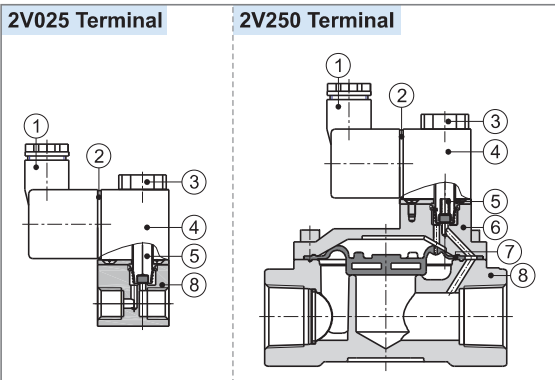

No.	Item	No.	Item	No.	Item
1	Connector	4	Coil	7	Diaphragm
2	Connector gasket	5	Armature assembly	8	Body
3	Nut	6	Body cover		

### Ordering code

2V 025 08 A □ G



① Model	② Orifice size	③ Port size	④ Voltage	⑤ Electrical entry	⑥ Thread type
2V: 2 port 2 position solenoid valve	025: $\Phi 2.5\text{mm}$	06: 1/8" 08: 1/4"	A: AC220V B: DC24V C: AC110V E: AC24V F: DC12V	Blank: Terminal I: Grommet	G: G Thread
	130: $\Phi 13\text{mm}$	10: 3/8" 15: 1/2"			
	250: $\Phi 25\text{mm}$	20: 3/4" 25: 1"			

### Specification

Model	2V025-06	2V025-08	2V130-10	2V130-15	2V250-20	2V250-25
Fluid	Air. Water. Oil					
Acting	Direct acting		Internally piloted acting			
Initial state	Normally closed					
Orifice size [Note]	2.5	2.5	13.0	13.0	25.0	25.0
Cv	0.23	0.25	6.20	6.20	13.00	13.00
Port size	1/8"	1/4"	3/8"	1/2"	3/4"	1"
Viscosity limit	Under 20CST					
Pressure range	0~1.0MPa(0~145psi)		0.05~1.0MPa(7~145psi)			
Proof pressure	1.5MPa(215psi)					
Material body	Brass with zinc plated			Brass		
Seal material	VITON			NBR		
Activating time	0.05 sec and below					

[Note 1] G thread is available.

### Specification of coil

Valve type	Power type	Frequency (Hz)	Voltage range	Electrical entry	Power Consumption (VA/W)	Insulation	Temp. rise (°C)
2V025	AC	50	$\pm 15\%$	Terminal Grommet	7.0VA	Class B	35
2V130		60					
2V250	DC	-	$\pm 10\%$		7.0W		45

### Usable fluid

Seal material\Fluid	Water	Dry air	Acetone*	ISOVG32 oil	Glycol*	Nitrogen	Heavy oil
NBR	○	○	△	○	○	○	○

Seal material\Fluid	JIS# oil	JIS#3 oil	Vegetable Oil	Inorganic Oil	Start Oil	Silicagel Oil	CO <sub>2</sub>	Argon
NBR	○	○	○	○	○	○	○	○

Note 1: ○ = Excellent (nearly without affect). ○ = Good (workable though some affect).  
△ = Poor (large affect).

Note 2: "\*" means inflammable and explosive dangerous fluid. Please use the relative explosion proof coil.

Note 3: Please consult the technical department before using fluid that has not been shown in the above table.

# Fluid control valve(2/2way)

## 2V Series

### Flow chart

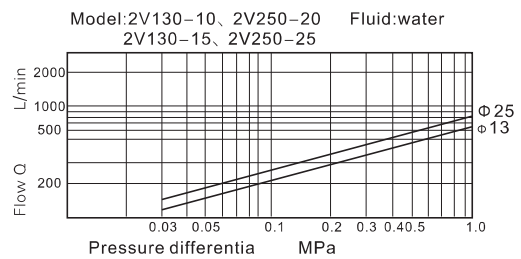
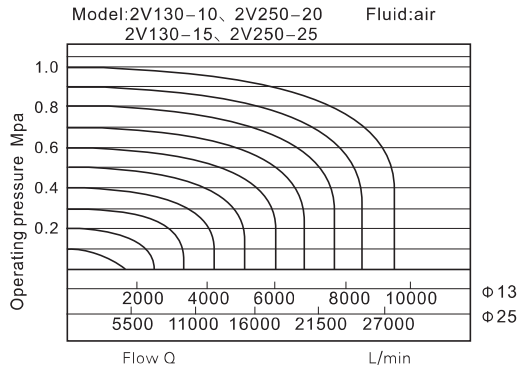
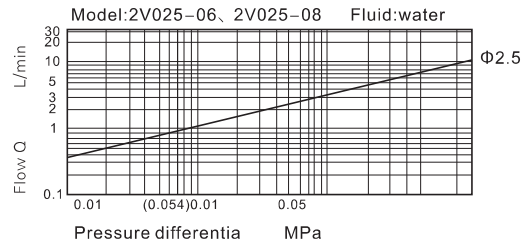
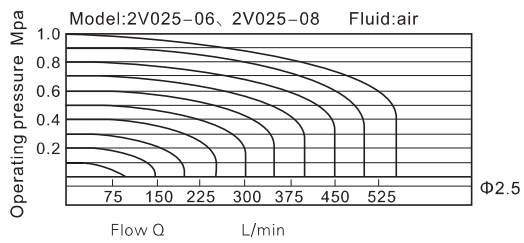

### Dimensions

#### 2V025 (Terminal)

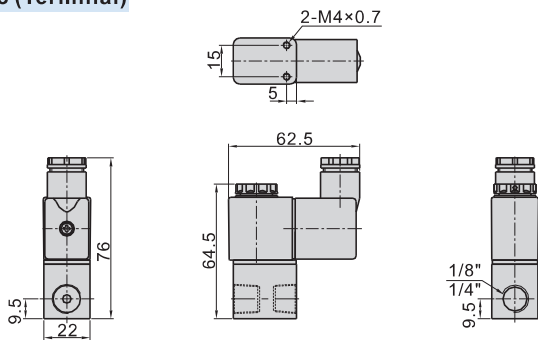

#### 2V025 (Grommet)

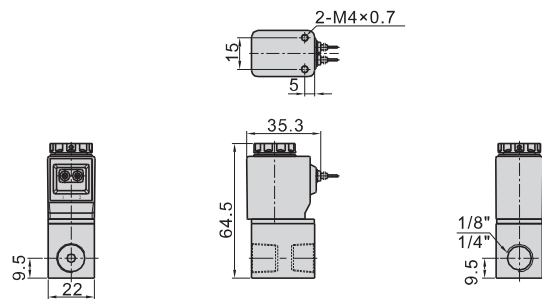

#### 2V130\250(Terminal)

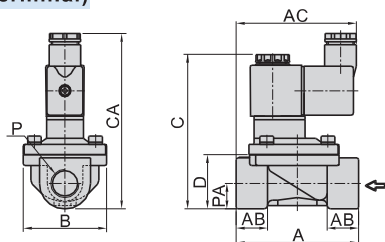

#### 2V130\250 (Grommet)

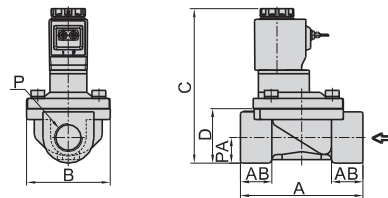

Model\Item	A	AB	AC	B	C	CA	D	P	PA
2V130-10	72	18.5	71	49	91	103	32	3/8"	15
2V130-15	72	18.5	71	49	91	103	32	1/2"	15
2V250-20	102	23	74	77.5	107.5	120	45	3/4"	21
2V250-25	102	23	74	77.5	107.5	120	45	1"	21